

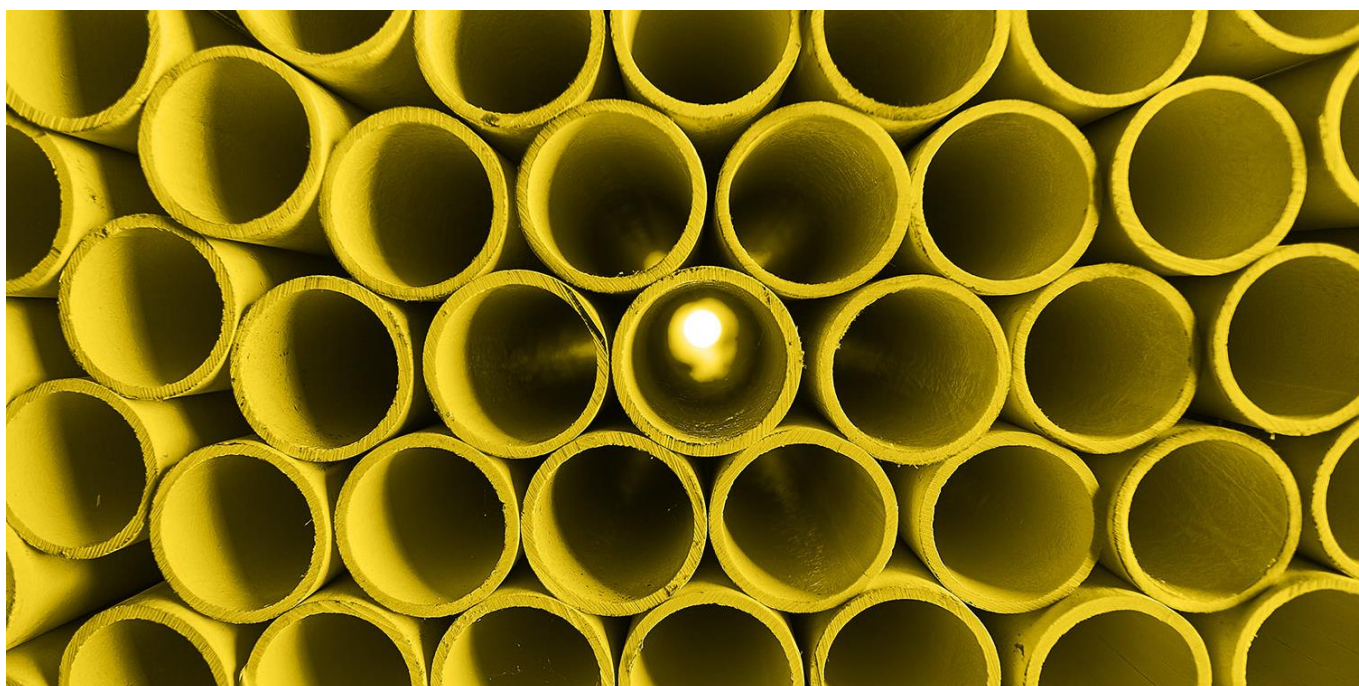

Gas Network

GTC Technical Guidelines

GTC Technical Guidelines and Safety Information for
House Builders and Developers



GTC Technical Guidelines

Contents

1. Introduction.....	4
2. Communications.....	5
3. Safety	6
4. Definitions	11
5. Developer Responsibilities.....	12
6. Gas Mains.....	18
7. Gas Services	21
8. Single Domestic Meters	26
9. Multi-occupancy Buildings.....	32
10. Pressure Reduction Installations.....	53
11. Non-domestic Supplies.....	58
12. Installing Meters and MPRN Issues.....	60
13. Appendices	62

Section One

Introduction

These guidelines provide you with information on the installation of gas mains, services, meters, and other parts of our gas networks. The guidelines also cover the safety aspects of GTC completing works onsite and specify your responsibilities in the delivery of the gas network.

Should you wish to contact us, the telephone number is 01359 240363.

Disclaimer

Although the greatest of care has been taken in the compilation and preparation of this document, GTC respectfully accepts no responsibility for any errors, omissions or alterations or for any consequences arising from the use, or reliance upon the information in this document.

Section Two

Communications

Our opening hours are from 08.00 to 17:00 every weekday. The below is a list of contact details for various parts of the customer journey.

Gas Emergency

If you can smell gas or believe a gas pipe has been damaged, please call **0800 111 999** (24 hours).

Electricity Emergency

To report No Supply or Electrical Damage, please call **0800 0326990** (24 hours).

Fibre Emergency

To report damage to a fibre plant or OSCP, please call **02920 028726**.

Sales

To discuss your utility infrastructure solution needs and obtain a quotation, please contact **01359 240154** or **sales@gtc-uk.co.uk**.

Design

To discuss a utility design or request a variation, please contact **01359 300798** or **network_variations@gtc-uk.co.uk**.

Legals

To discuss legal transactions in relation to

easements and transfers over our utilities, please contact **01359 243453** or **legals@gtc-uk.co.uk**.

Site Installation

To book in work on your site, please contact **0345 602298**

45 6022498 or **gtcworks@gtc-uk.co.uk**.

Meter Point Numbers

Request or query MPRN numbers, please contact **01359 243311** or **mprn.requests@gtc-uk.co.uk**.

Supplier Agreements

To check and change supplier/shipper contract agreements, please contact **01359 243311** or **psr@gtc-uk.co.uk**.

Finance Queries

For any queries regarding invoices or billing, please contact **01359 308144** or **credit.control@gtc-uk.co.uk**.

Customer Services

At GTC, we are committed to providing you with excellent customer service and we encourage feedback so that we can ensure we are making our customers happy. If you have any comments or complaints about our service, please contact **01359 302640** or **customerservices@gtc-uk.co.uk**.

Section Three

Safety

Safe Place of Work

GTC requires a safe place of work to be provided for all its staff and contractors. We will seek confirmation that the construction site is a safe place to work.

Upon arrival on site, staff and contractors will report to the Site Manager/Representative to discuss intended works. Prior to undertaking this work, a site-specific risk assessment will be undertaken. If, following this assessment, the works cannot be undertaken in a safe manner, the Site Manager/Representative will be informed. Until a safe working environment is achieved, no activities shall be undertaken.

Site Traffic Rules

All site traffic information should be made available to the team/operative when arriving on site, via a site induction or during the booking in on-site stage.

Equipment and Materials

All materials will be handled, transported, stored and fixed in accordance with the manufacturer's requirements. Any conflict between such requirements, this documentation and the British Standards Institution, shall be referred to GTC in writing for a decision.

The Site Manager/Representative shall ensure their equipment and materials are operated and stored in such a manner that they do not become a hazard within the working area of the GTC team/operative.

Scaffold

Ensure all scaffolding where the team/operatives are to work is removed prior to their arrival on site.

Waste

In most cases, GTC will make use of the waste collection and disposal facilities on site from the Principal Contractor. If this is not possible it should be discussed with your local Project Manager.

GTC Technical Guidelines

Welfare Facilities

In the majority of cases, welfare facilities are to be made available on site from the Principal Contractor.

Competence

Any staff and/or appointed contractor working on behalf of GTC who attend site will have the appropriate training, technical knowledge and experience to discharge the intended works in a safe manner.

Construction Design Management (CDM) Regulations

GTC will act as the 'Designer' and 'Contractor' for the construction and commissioning of gas networks on new property developments.

The gas mains, services and meters that will be installed on the development will remain the property of the licenced Gas Transporter named in your quotation. GTC will be responsible for the operation and maintenance of the network on behalf of the Gas Transporter.

The construction team should leave a marked-up copy of what is live in the site agent's office during the construction phase so that other construction workers have access to live plant information.

Recommended Positioning of Utility Apparatus

In accordance with the Institution of Gas Engineers and Managers guidance and Health and Safety Executive expectations, gas mains and services must be laid at the depths specified in sections 6 and 7 of these guidelines.

The typical NJUG position of the gas main and other utilities apparatus in a footway is shown in Figure 1, however where GTC are installing gas, electric and fibre, the low voltage electric cables and fibre ducts should be installed at 600mm depth as shown in figure 2. The typical position in a road/verge is shown in Figure 3.

All dimensions shown are in mm.

GTC Technical Guidelines

This diagram is NOT to scale and indicates the typical depth of cover required.

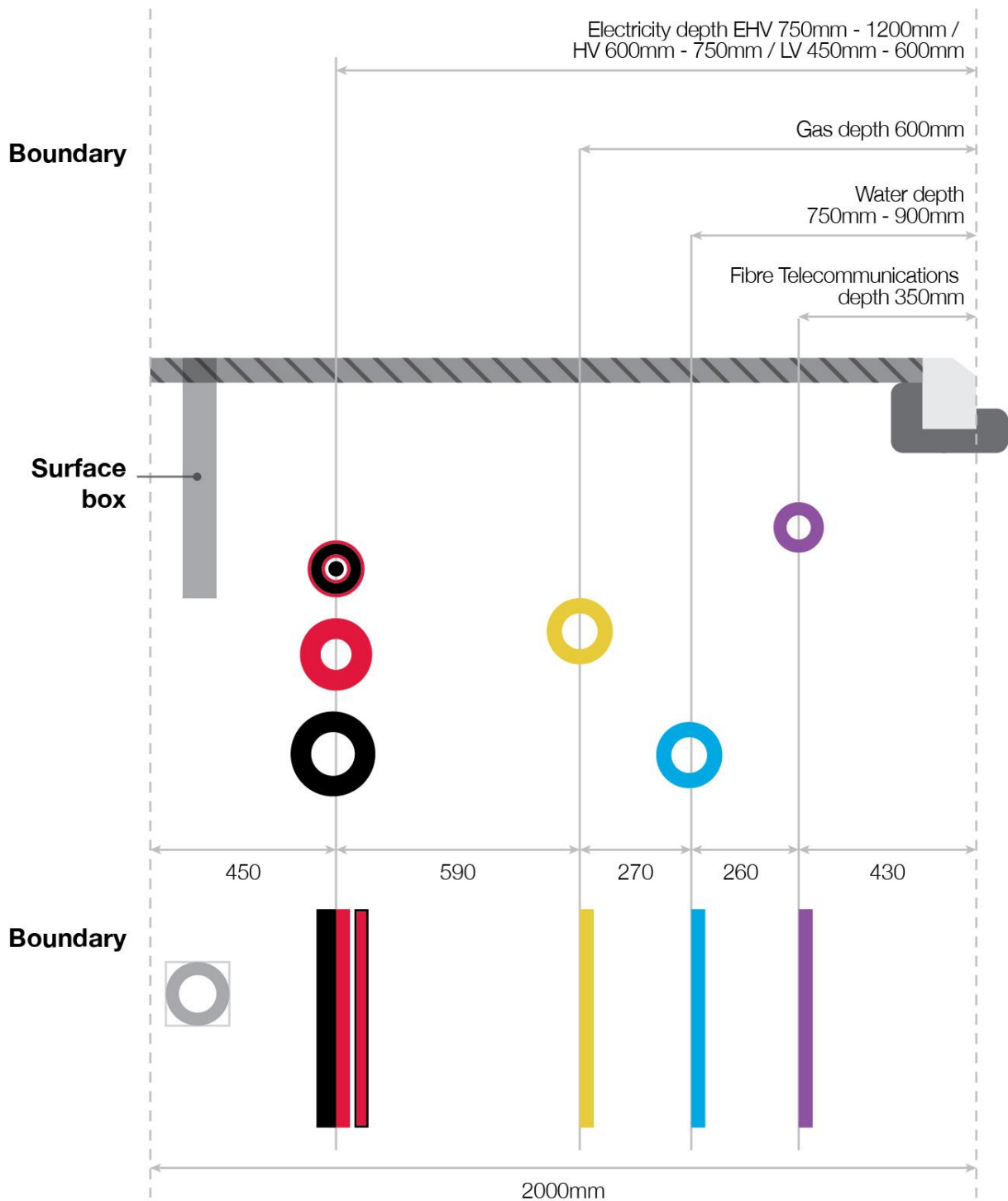

Figure 1 – NJUG positioning of utility apparatus in a two metre footway

Note: Irrespective of footpath width, the gas main shall have a minimum 250mm proximity from all other utility apparatus.

GTC Technical Guidelines

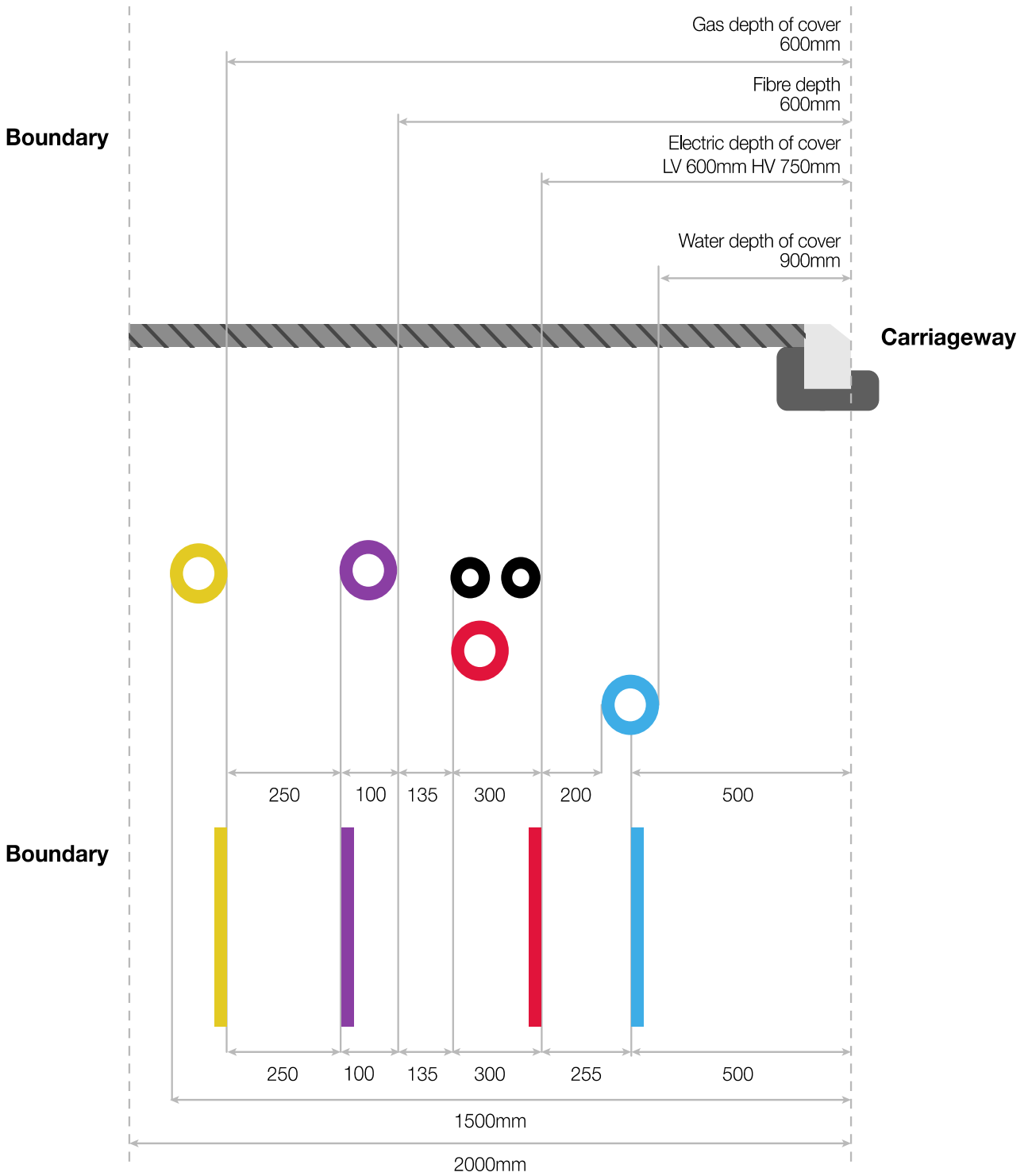

Figure 2 – GTC positioning of multi-utility apparatus in a two metre footway (Gas, Electricity and Fibre)

GTC Technical Guidelines

This diagram is NOT to scale and indicates the typical depth of cover required.

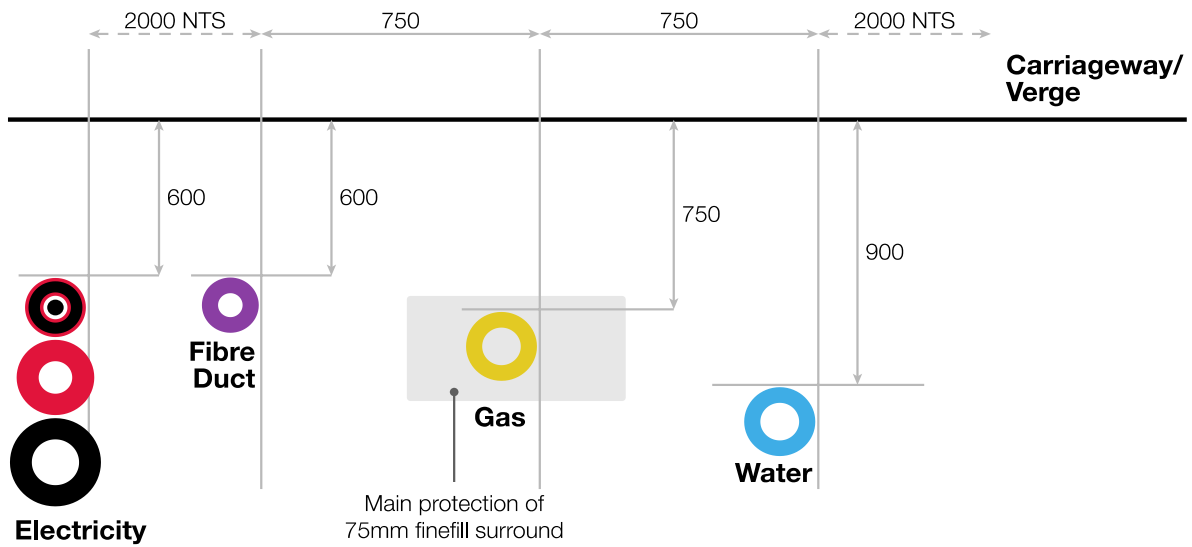

Figure 3 – Typical road section to show relative positions of utility apparatus

It is imperative that the gas mains are not damaged following installation, and it is the responsibility of the Developer to ensure that ALL contractors working on site are informed of the location of the gas mains. The mains and services drawing should always be on site and updated to clearly show the installation progress.

Please note that other Gas Transporters may have gas mains near the site. They should be contacted by the Developer at an early stage to establish the location of any non-GTC mains that may be affected.

Damage to live gas mains and services must be reported immediately to the **National Gas Emergency number 0800 111 999** who will arrange for the Emergency Service provider to attend site and undertake any repairs.

Any damage to un-gassed pipes, no matter how slight, must be reported immediately to GTC.

For further information refer to HSE publication HSG47 *Avoiding Danger from Underground Services* which gives detailed guidance on avoiding damage to gas mains and services, including information on detecting underground services and safe digging practices. Free information is available from the **HSE Infoline on 0845 345 0055** or the **HSE website <http://www.hse.gov.uk>**.

Section Four

Definitions

External Service Riser	A riser attached to the outside of a building or concealed in an external reveal.
Gas Main	Underground pipe network for distributing gas throughout the property development.
Gas Service	Underground pipe for conveying gas to premises from the gas main.
Gas Transporter	A company licensed under the Gas Act to operate pipes on a network and has control over them for conveying gas.
Installation Pipe	The pipe work in a consumer's premises between the outlet of the meter and the appliances.
Internal Service Riser	A riser installed within the structure of a building.
Low Pressure	The usual operating pressure of the network, which does not exceed 75mbar (gauge).
Medium Pressure	The operating pressure in the Gas Main and Service when it exceeds 75mbar (gauge). In these circumstances additional safety features apply to the design of the meter installation. See section 8.
Meter Box	A purpose made glass reinforced polyester moulding to house domestic and small non-domestic meters.
Meter Compartment	A room or cupboard specifically designed to house the meter installation.
NJUG	National Joint Utilities Group.
Regulator	A device whose function is to control pressure in a gas stream.
Ventilation	The movement of air and its replacement with fresh air because of wind and temperature gradients.

Section Five

Developer Responsibilities

The Developer is responsible for ensuring that the on-site requirements detailed below are met:

General

- Ensure kerb braces have been installed prior to scheduling work with GTC. **IN EXCEPTIONAL CIRCUMSTANCES ONLY** where this is not practical or reasonable and with the express written permission of the Gas Networks Director, GTC may accept a site-specific indemnity letter signed by the Developer accepting a “line and level” approach. In such circumstances the Developer will indemnify GTC against all costs relating to future relocation of all utility pipes, ducts, and cables and/or repairs to damaged pipes and ducts.
- Carry out all necessary excavation and backfilling work for the installation of gas mains, services, and associated equipment.
- Maintain an obstacle free route to allow installation work to be carried out in one visit wherever possible.
- Ensure no work is carried out beneath scaffolding.
- Ducting, supplied by the Developer, can only be used for perpendicular road crossings.
- Ensure groundworkers installing gas service pipes are shown and fully understand the GTC Gas Service Installation Video as detailed in section 7.1.
- Ensure that you have read, understood, and signed **CDM Construction Plan Parts C and D GU-DPR-FM-1014**.
- Ensure groundworkers are trained, competent and registered to lay ducting and/or services in accordance with the design drawing.
- Maintain a register of trained and competent groundworkers in Appendix 1.
- Lay ducting for mains in accordance with the design drawing.
- Lay ‘gas pipe’ marker tape, supplied by GTC, 250mm above gas mains or ducting for mains before backfilling the trench.
- Lay ‘gas pipe’ marker tape, supplied by GTC, 75mm above gas service or ducting for services before backfilling the trench.
- All gas mains and services must be 250mm away from other utility services.
- In accordance with the Pipeline Safety Regulations, the service must be as short as possible and therefore the meter position shall terminate on the building elevation nearest the gas main; in certain circumstances as determined at the design stage, services may terminate at a meter box on a side elevation, but no more than 2 metres from the nearest elevation to the main.

GTC Technical Guidelines

- Install meter boxes, supplied by GTC, at a suitable height to provide enough cover to the service, and ensure doors or lids are fitted.
- Provide a suitable safe access platform for installation of all gas riser works.
- Ensure that the gas riser entry points into the building and through floors on flatted properties, have been suitably drilled and sleeved without the need for offsetting the pipe work.
- Where necessary, ensure that the gas riser and sleeve which pass through each floor on flatted properties, are fire stopped in accordance with building regulations.
- Store materials used in the gas network safely and in accordance with the section below.

Materials Delivery & Storage

In preparation of GTC completing work on-site, there is a requirement for the Developer to responsibly store pipe and fittings on site. The following guidelines identify best practice; however further guidance and advice can be provided by the GTC Project Manager and the Institution of Gas Engineers and Managers publication IGEM/G/8, *Handling, Transport and Storage of PE Pipes and Fittings*.

- Pipe, meter boxes and associated equipment will be delivered directly to site and must be visually inspected on delivery and any damage immediately reported to GTC.
- Any loss or damage occurring after delivery will be chargeable to the Developer.

Storage

The onsite storage facilities shall be a secure compound. Careful consideration should be given to the following aspects:

- Security of all materials and equipment from theft, vandalism, accidental damage, or contamination. Precautions should be taken to prevent debris and water from entering pipe and fittings. (Pipe end caps on coils, intended to prevent ingress of contamination, should be kept in place during storage).
- Safety of the site workers, public, especially children and blind persons.
- The movement of traffic and construction equipment.
- All pipe store locations should be on a suitably firm hard standing, level ground, free from ground water, mud, and other damaging material with adequate access for construction vehicles and/or lifting equipment.
- Badly stacked pallets, coils or bundles may slip or collapse, causing injury to personnel and/or damage to the pipe.
- Pipe and fittings are not to be stored on the ground, suitable pallets or wooden battens should be the interface between the ground and material.
- Care should be taken to prevent damage to, and distortion of, pipe ends and fittings.
- Stock should be stored in such a manner as to ensure adequate stock rotation on a “first-in, first-out” basis.

GTC Technical Guidelines

Individual Pipe Lengths

Pipe lengths stored individually should be stacked on clear level ground in a pyramid not more than one metre high, with the bottom layer fully restrained by wedges. The bottom layer of pipes should be laid on timber battens at one-metre centres.

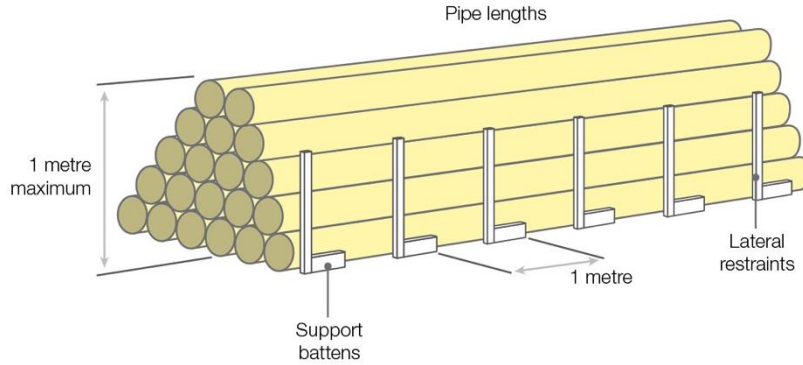

Figure 4 – Storage of loose pipes

Bundled Pipe Lengths

Bundled packs of pipe should be stored on clear, level ground, with the battens supported from the outside by timbers or concrete blocks. For safety, bundled packs should not be stacked more than three metres high.

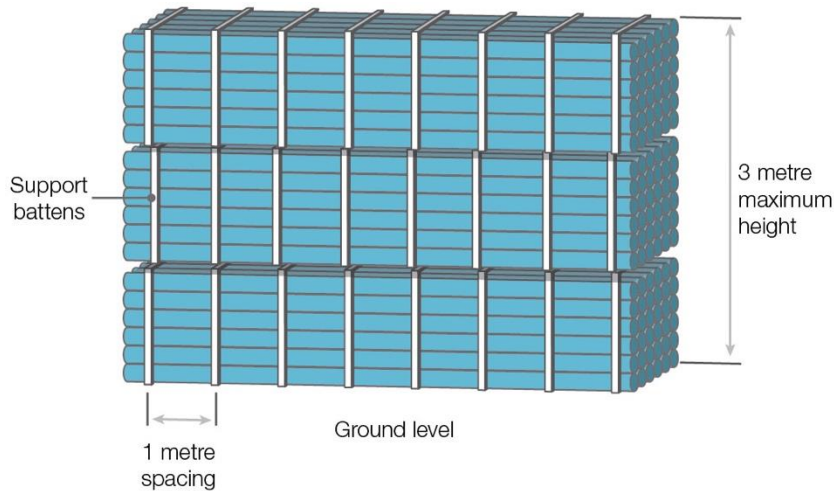

Figure 5 - Storage of bundles of pipes

Broken bundles

Where pipe lengths are to be removed from a bundle, it should be from a single bundle with no unbroken bundles underneath; stakes should be securely fixed to retain the bundle shape whilst stock is drawn from the bundle.

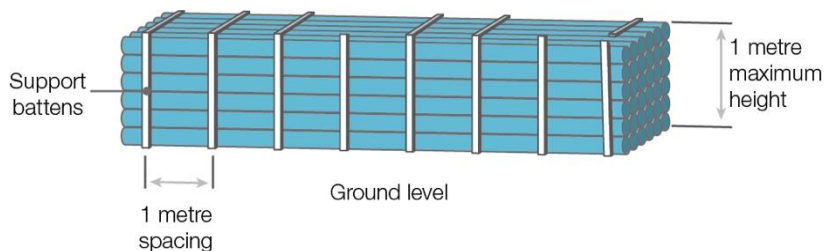

Figure 6 – Broken bundles of pipes

GTC Technical Guidelines

Small Wrapped Coils (diameter $\leq 32\text{mm}$)

Coils of pipe of diameter up to 32 mm are normally restrained using an outer covering of “shrink wrap” or equivalent material to enable pipe to be drawn from the centre of the coil. Only enough pipe for immediate use should be cut from the coil and on no account the outer wrapping be removed until the coil is almost fully unwound. The dust cap must be replaced on every occasion a cutting is taken from a coil. The coils should be placed on a hard standing.

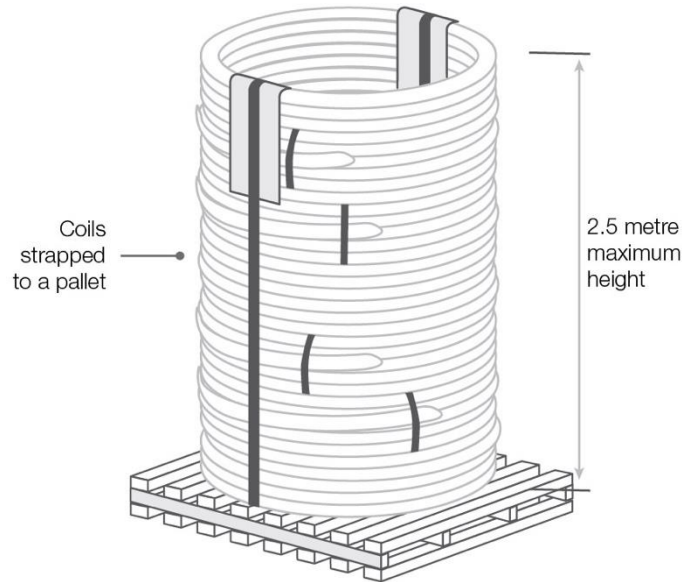

Figure 7 – Small wrapped coils (diameter $\leq 32\text{mm}$) storage

Individual coils should be stored on pallets or on firm level ground which has suitable protection for the bottom coil. The stack height shall not exceed 2.5 m. Battens or other similar provision should be provided between coils to facilitate lifting. Coils delivered by suppliers already palletised may have been secured by shrink wrap or retaining straps; such coils should remain secured to their respective pallets during storage with the stack only being broken at the time of issue.

The height of stacked individual coils not secured to a pallet shall be such that the stack is stable, and the uppermost coil can be safely handled. Individual coils of pipe of diameter not exceeding 32 mm should be hand stacked flat.

GTC Technical Guidelines

Large Coils (diameter $\geq 63\text{mm}$)

Coiled pipe should be stored flat, especially during periods of warm weather, and on firm level ground which has suitable protection for the bottom coil. Where space is limited, and coils are to be stacked, the height of stacked coils should be such that the stack is stable, and the uppermost coil can be safely handled. Under no circumstances should the stack exceed 2.0 metres in height. Wooden battens placed below the bottom coil and used as spacers between each layer will facilitate easy access for slinging. When the need for transportation is required, it should only be carried out by trained operatives. Batches of coils delivered on pallets must remain secured to the pallet and only be broken at the time of use. Vertical storage of PE coils shall only be with the agreement of the GTC Project Manager in suitable racks.

WARNING: Under no circumstances shall a person not competently gas trained cut the bands on coiled PE pipe.

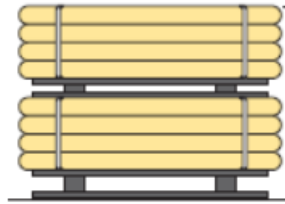

Figure 8 – Large coils (diameter $\geq 63\text{mm}$) storage

The maximum height of coils stored horizontally shall be 2 metres.

Fittings

Electrofusion fittings should be stored under cover in dry conditions, preferably on racking in a lockable container. They should be kept in their boxes/package until ready for use. Fabricated fittings may be stored outdoors if they are protected against damage and prolonged direct sunlight.







GTC Technical Guidelines

Ground Workers

Ensure ground workers have enough knowledge about safe working practices on site and that work is carried out safely. Any ground workers installing gas service pipes and/or ducts must only do so with the permission of GTC.

- Ground workers must be aware of the large amount of stored energy in coils of pipe. Coils of pipe should be carefully restrained and unwound following the guidance in section **Materials Delivery & Storage**.
- Where connections are to be made to an existing gas main, the GTC Project Manager shall advise the Developer/groundworker of the type of connection to be undertaken and the dimensions of the excavation necessary to facilitate the connection.

Table 1 – Minimum excavation requirements to support connections

Minimum excavation requirements to support connections. Excavation base to be 150mm below pipe				
Connection type	Applicable mains diameters	Excavation size required for the live main to be exposed (mm)	Additional bell hole in middle in direction of offtake (mm)	Excavation shape
End on connection	≤180mm mains diameter	2070 x 680	n/a	
	250/315mm diameter	3285 x 815	n/a	
Insert tee	≤180mm mains diameter	7220 x 680	1000 x 680	
	250/315mm diameter	10560 x 815	1000 x 815	
Branched offtake	≤180mm mains diameter	1500 x 680	1000 x 680	
	250/315mm diameter	1500 x 815	1000 x 815	

Section Six

Gas Mains

General

A pre-start site meeting will be arranged at the start of your development. At any stage of construction, you can contact GTC for advice and guidance.

It is desirable that the Developer agrees a programme of construction which will enable GTC to co-ordinate main laying activities, within our set timescales.

Timescales are particularly important when off-site mains must be laid and connected to another upstream Gas Transporters network and approval is required from the Local Highways Authority to work in the public highway.

The Developer is responsible for all excavations, duct laying and backfill work on site, unless otherwise specified within the quotation.

On request, GTC will normally arrange for the on-site mains to be laid in trenches and/or ducts provided by the Developer.

If there are any alterations to the agreed site layout, which may affect the route of the gas main, then GTC must be advised immediately.

Mains Excavation

The minimum depth of cover for mains and ducts should be 600mm in footways and 750mm in roadways/verges from the finished ground level.

The trench should be approximately the pipe diameter plus 300mm wide and minimum cover plus the pipe diameter deep.

The bottom of the trench should be trimmed to enable the main to be bedded evenly and consistently throughout the trench, at the correct cover. Sharp stones should be excluded from the base of the trench. Where the base of the trench is unsuitable e.g. rocks and stones, the trench should be excavated a further 75mm and a bed of suitable fine material laid and compacted.

GTC Technical Guidelines

Gas mains and services should be a minimum of 250mm from all other utility apparatus. Where gas services cross other utility apparatus within 250mm, the gas service shall be ducted. Where other utility apparatus crosses the gas main within 250mm the service shall be ducted or a suitable barrier provided to ensure physical separation.

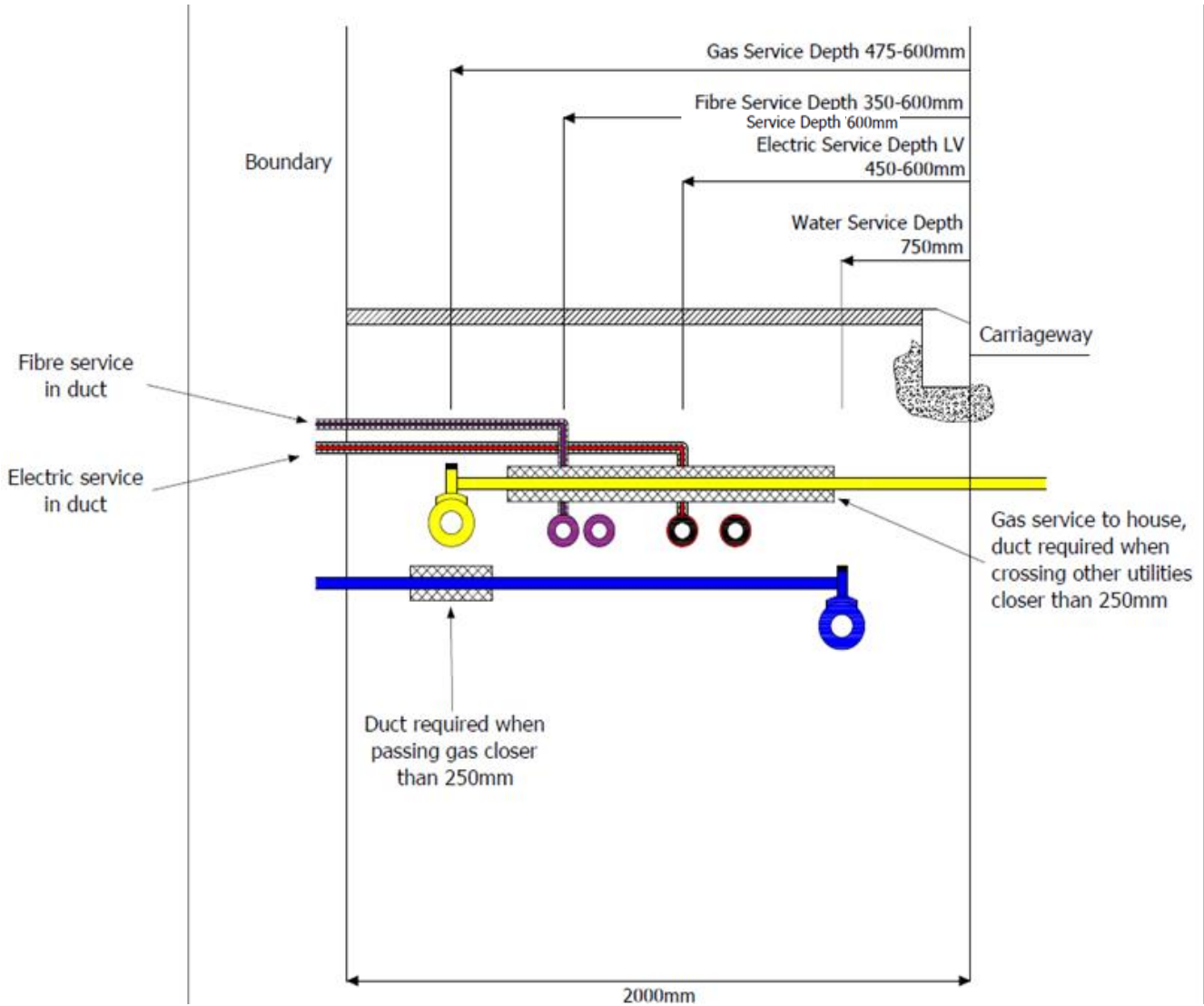

Figure 9 – Typical footpath section to show relative service positions

Mains Ducting

The laying of mains across roads can be in an open trench excavated by the Developer, however, yellow rigid plastic ducting can be used as defined in NJUG publication *Volume 2 NJUG Guidelines on the Positioning of Underground Utilities Apparatus for New Development Sites*, but for perpendicular road crossings only.

The Developer is responsible for the supply and installations of ducting. A suitable standard for plastic ducting is BS 4962.

Corrugated ducting must not be used for road crossings.

GTC Technical Guidelines

Table 2 – The diameter of duct required for each size of main

Diameter of main	Internal diameter of duct
63mm	100mm
90mm	150mm
125mm	200mm
180mm	300mm
250mm	300mm
315mm	400mm

Backfill Materials

The Developer must arrange for their ground workers to be on site at the time when mains are being laid to ensure that the mains are surrounded by fine material e.g. sand or pea shingle to a depth of 150mm above the main as soon as possible to avoid damage. Mains will not be tested and commissioned until this partial backfilling is complete.

Backfill and sub-base materials must be free from any organic, perishable, or hazardous material.

A 'gas pipe' marker tape, supplied by GTC, must be incorporated within the backfill for all mains and road crossing ducts and be positioned 250mm above the main or duct as shown below:

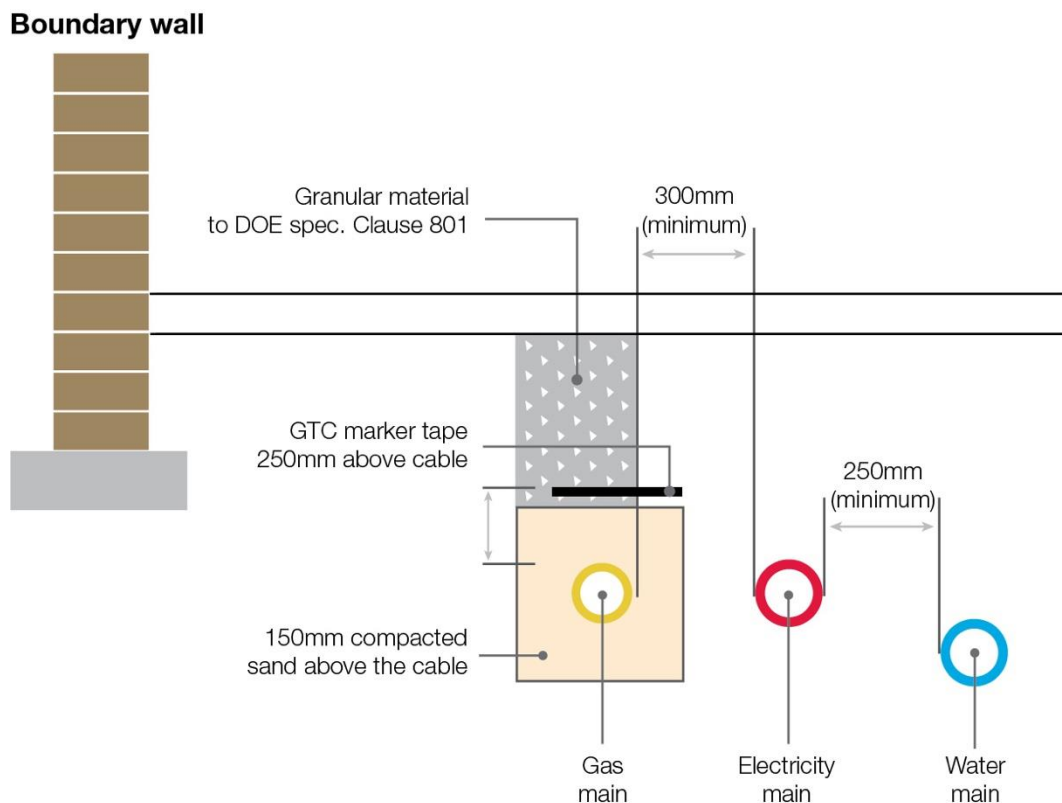

Figure 10 – A 'gas pipe' marker tape position

Section Seven

Gas Services

General

The Developer is required to undertake all excavation works on-site to enable the service pipe or service ducting to be laid, allowing the connection to the main and the service termination at the building to be completed.

The Developer is responsible for ensuring that all groundworkers installing gas service pipe and ducting are shown and fully understand the GTC Gas Service Installation Video. The video is accessed using a QR code which will be issued to the Site Manager/Agent by the GTC Project Manager at the pre-start meeting. An up-to-date register of those individuals installing gas service pipe and ducting must be recorded in Appendix 1 and kept by the Site Manager/Agent.



Use QR Code to access the *Groundworkers Guide to Laying Gas Service Pipe* video.

Password **GTCVideo**

The gas service must be laid in a straight line along a route as shown on the agreed design, any deviations must be agreed with GTC, prior to laying the service pipe or service duct. The route should be perpendicular to the property and take the shortest route practicable to the gas main.

A gas service must not run parallel to the gas main.

The service pipe shall be inserted through a preformed PVC bend and GRP sleeve as it rises to cavity/inset boxes. The preformed bend ensures the service pipe does not exceed its maximum bending radius and indicates the depth of the service pipe. The preformed bend should not extend above ground level by more than 25 mm. GRP sleeves should be vertically straight from bend to box and secured to the wall using an appropriate clip.

Services shall be laid, in trenches or inserted into ducts provided by the Developer. The ducting should be a minimum of 60mm diameter, must be yellow and perforated along its entire length.

GTC Technical Guidelines

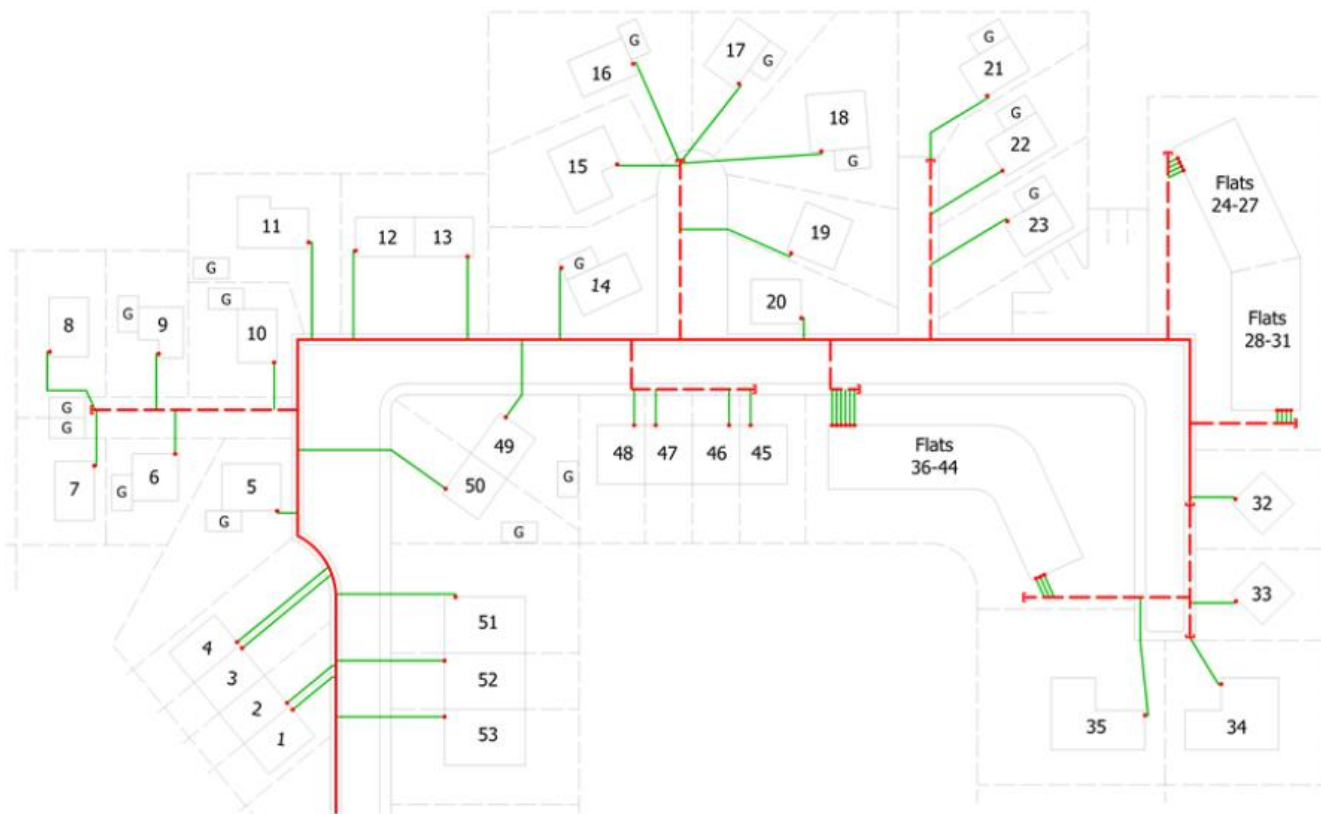

Figure 11 – Example of acceptable gas service routes

GTC Technical Guidelines

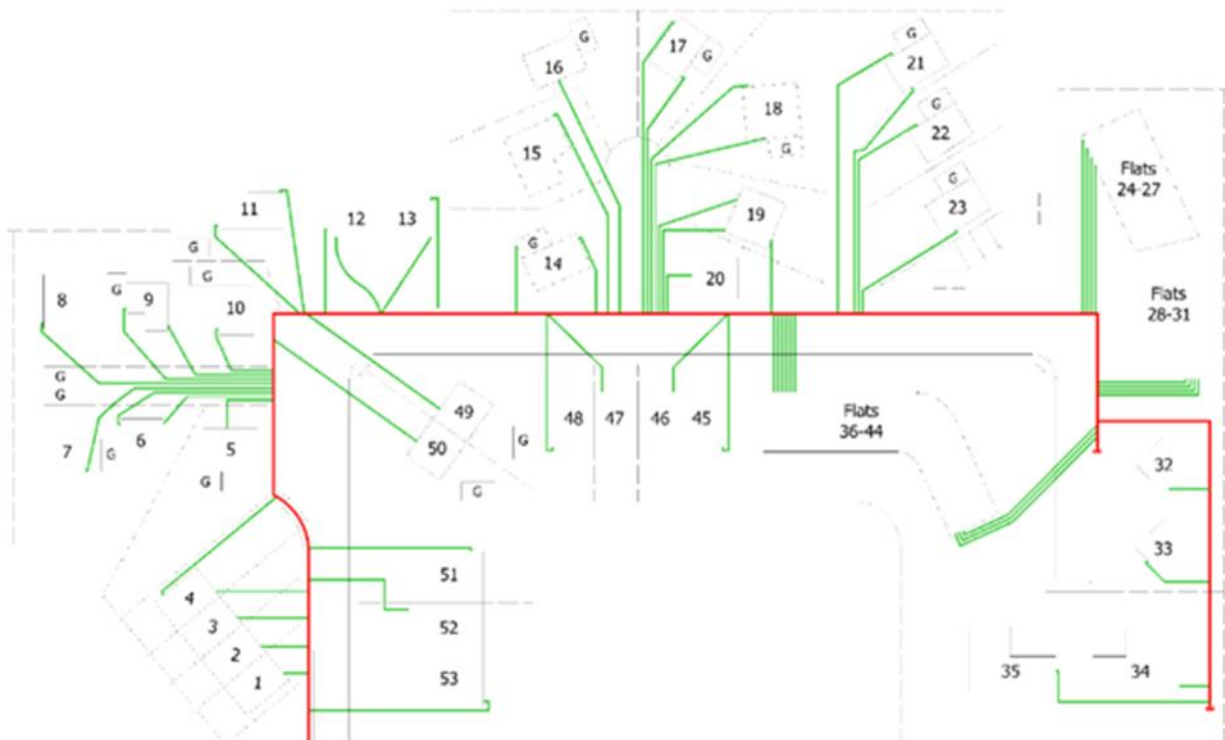

Figure 12 – Example of not acceptable gas service routes

Note 1: Services should wherever practicable, be the shortest possible route and wherever reasonably practicable, perpendicular to the nearest elevation of the building to the main; where meters are located on an adjacent elevation, it shall be no more than 2 metres from the nearest elevation to the main.

Note 2: Mains passing through rear gardens should not be considered an option.

GTC Technical Guidelines

Service Pipe, Ducting & Excavation

When necessary, the Developer is responsible for the supply and installation of ducting for service pipes. The gas ducting must be to British Standard BS 4962 *Specification for Plastic Pipes and Fittings for use as Sub Soil Drains*. The ducting should be a minimum of 60mm diameter, must be yellow and perforated along its entire length. It should be installed in a straight line between the meter position and the mains connection. Under no circumstances should a PE gas or water pipe be used as a duct. The ends of the duct must always be capped or plugged to prevent ingress of debris.

Service pipe and ducting must be laid with a minimum depth of 600mm (private and public) from the finished ground level.

Marker tape (provided by GTC) must be placed 75mm above the entire length of the service, irrespective of the service pipe being in a duct. Service pipe and ducting must not be kinked, squashed, or damaged and should be backfilled with fine material e.g. sand or pea shingle to a depth surround of 75mm to prevent any damage occurring during final reinstatement.

If the installed service pipe or ducting has insufficient cover, or no marker tape has been laid above the pipe or ducting, or the duct ends have not been sealed, then the service will not be installed/commissioned, and the Developer will be notified.

A 1 metre square excavation is required at the gas main and below the meter box or service entry position to enable the service pipe to be connected to the gas main and terminated at the meter location.

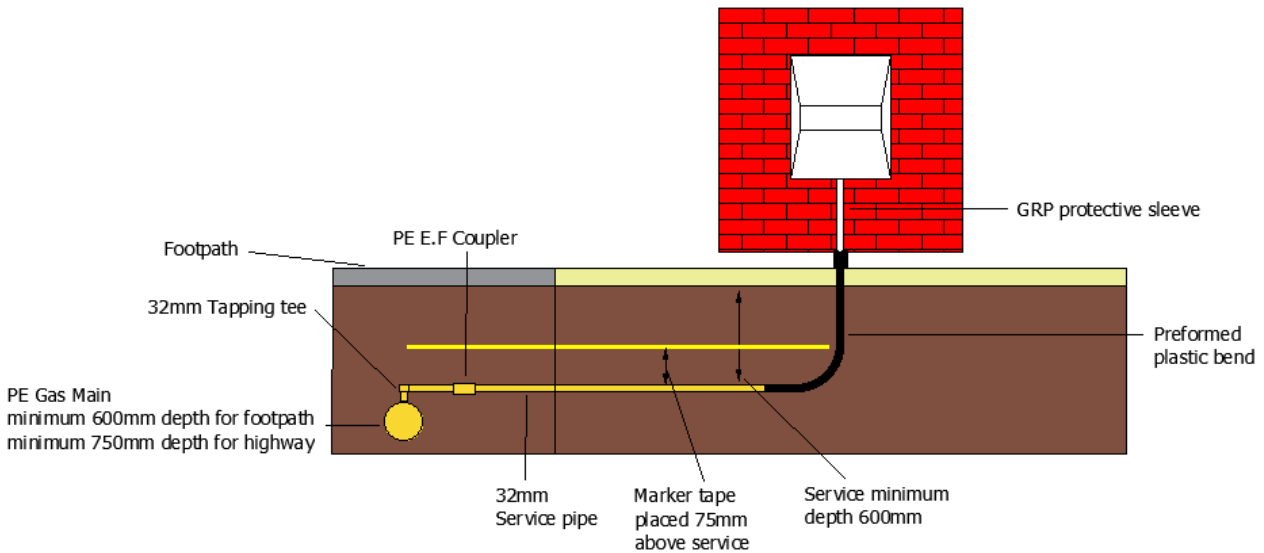

Figure 13 – Service pipe and ducting installation

GTC Technical Guidelines

Service Isolation Valves

A gas service pipe that incorporates an external isolation valve (for I&C and flatted properties) will require a gas surface box which must always remain accessible. This will be supplied by GTC, but the Developer is responsible for installing the box as part of the permanent reinstatement as shown below:

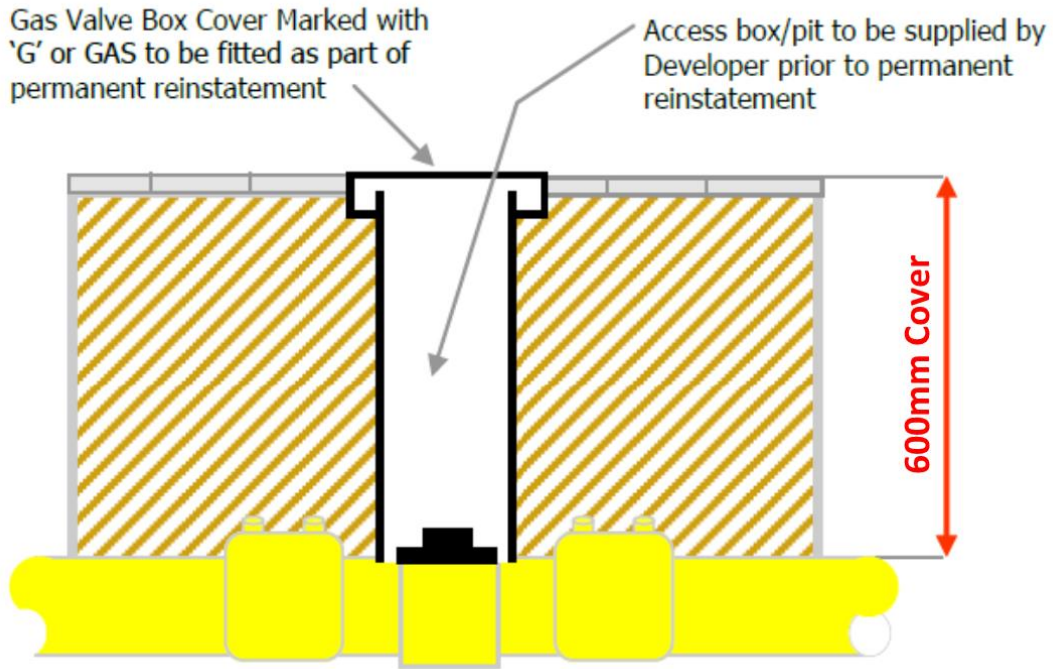

Figure 14 – Gas surface box installation

Section Eight

Single Domestic Meters

General

It is the Developer's responsibility to identify and consult with GTC to ensure that adequate provision is made for siting, installing, and housing the meter installation. The Developer should provide a site plan showing the required meter positions before the final design of the gas services can be approved. Once the design is approved, any variations required shall be submitted to GTC for approval. GTC shall be the sole arbiter of meter positions.

As part of the quotation acceptance the Developer should notify GTC of their chosen Gas Shipper.

Services & meters will be installed to substantially completed properties. When booking services and meter fits the Developer is required to confirm the GTC network number, plot number and meter box type. It is preferred that a minimum of three services are booked and connected on each visit.

Where smart meters are installed to facilitate the correct pairing it is important that the gas meter is installed prior to the electricity meter.

Meter installations shall be sited so that:

- The installation is compliant with BS6400-1.
- The meter and or the regulator can be installed, adjusted, serviced, and exchanged.
- The meter is easily accessible for inspection and meter reading.
- All functions of the installation can be easily operated.
- Does not create a trip hazard along access and egress routes.

A meter installation shall not be sited:

- Where it might be exposed to extreme temperatures, excessive humidity, vibration, or ignition sources outside the operating range of the meter as specified by the manufacturer.
- Where it might be exposed to accidental damage.
- Where it might cause an obstruction.
- Where it might be affected by a damp or a corrosive atmosphere.
- Where it will constitute a danger to any person.
- At such a low level that there is a significant risk of it being submerged in the event of flooding.
- On the sole means of escape from the premises in the event of a fire unless the site where it is to be installed is such as to ensure, so far as is reasonably practicable, that the means of escape from those premises in the event of fire is not adversely affected; or
- In an unventilated space.

GTC Technical Guidelines

The following locations may be used for gas meter installations:

- In a purpose made meter box.
- In a compound outside the building.
- In a garage or outbuilding.
- Inside the building at the sole discretion of GTC.

Electrical Installations

For the purposes of design, meters installed in domestic premises, in either an internal location or in a meter housing, are deemed to be in a Zone 2 hazardous area as defined in DSEAR.

For low pressure installations the minimum distance from a gas pipe to an electricity cable inside a property should be 25mm, and 150mm from an electricity meter box or any switchgear.

Electricity service cables must not be installed directly behind a gas meter box.

Electrical Cross Bonding

An electrical cross bonding wire (where required) should be connected to the gas meter outlet in accordance with IEE Regulations. When the bonding wire enters a built-in box from the rear it must pass through the outlet installation pipe spigot (other routes are not permissible) and be contained within the seal. The box must not be broken to accommodate the bonding wire; all holes or cracks in the meter box shall be repaired and all costs borne by the Developer.

Meters Located Outside

Meter installations sited outside the building shall be housed in one of the following:

- Built-in/cavity meter boxes.
- Universal meter boxes.
- Surface-mounted meter boxes; or
- Purpose-built housings designed for low pressure meter installations.
- Note: Semi concealed meter boxes are not permissible.

Meter boxes shall conform to BS 8499.

The fitting of meter boxes and the installation pipe is the responsibility of the Developer and must comply with the current version of the Gas Safety (Installation and Use) Regulations.

Meters will not be installed in damaged, un-secured or incorrectly located boxes. A damaged meter box is in contravention of the Gas Safety (Installation and Use) Regulations and must not be installed. If a box is damaged after being installed, then it must be replaced, before the gas service and meter are connected.

A meter will not be installed unless the door on a built-in box or surface mounted box is fitted or if the box is not installed to the correct level or adequately fixed to the wall.

GTC Technical Guidelines

All meter housings shall be designed and installed such that:

- They are impermeable to gas and do not allow escaping gas to enter the wall cavity or property.
- They give protection against the weather and acts of vandalism.
- They are resistant to the surface spread of flame in accordance with BS 476-7:1997, Class 2.
- They do not bridge the damp proof course.
- Consumer access is gained only by a special key, and it is the Developer's responsibility to provide this key to the householder.
- The consumer has ready access to the ECV.
- They incorporate ventilation that is a minimum of 2% of the plan area (1% at high level and 1% at low level) provided by purpose-designed vents of the non-closable type to achieve at least a Zone 2 hazardous area within the meter housings.

GTC Technical Guidelines

Built-In/Cavity Box

These boxes have been designed for insertion into the external leaf of a cavity wall. They are suitable for conventionally built or timber-framed dwellings.

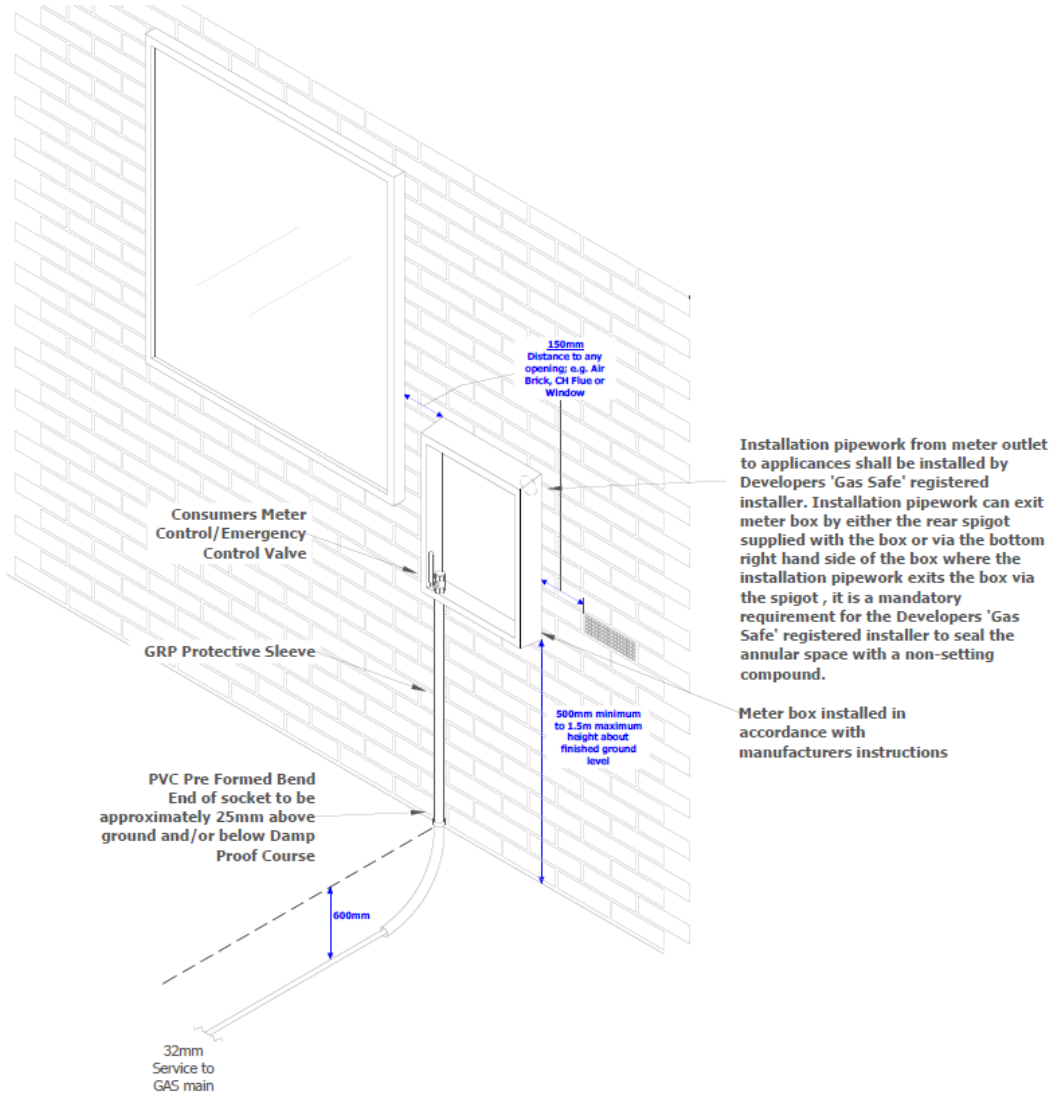

Figure 15 – Cavity box installation

The base of the box should be located preferably between 500mm and 1500mm above the finished ground level in accordance with the manufacturer’s instructions.

The box must be installed and secured using cement or adhesive filler. It must not be secured using screws or nails as this could allow any leaking gas to enter the cavity.

The outlet spigot must fully bridge the cavity. These boxes are only to be used for Low Pressure services. Medium Pressure meter installations require a surface mounted meter box, further advice can be provided by the GTC Project Manager.

GTC Technical Guidelines

Universal Box

The Uni-box can be partly buried at the foot of the house wall but protruding above the ground level at the wall. The depth of the box from the wall is 290mm.

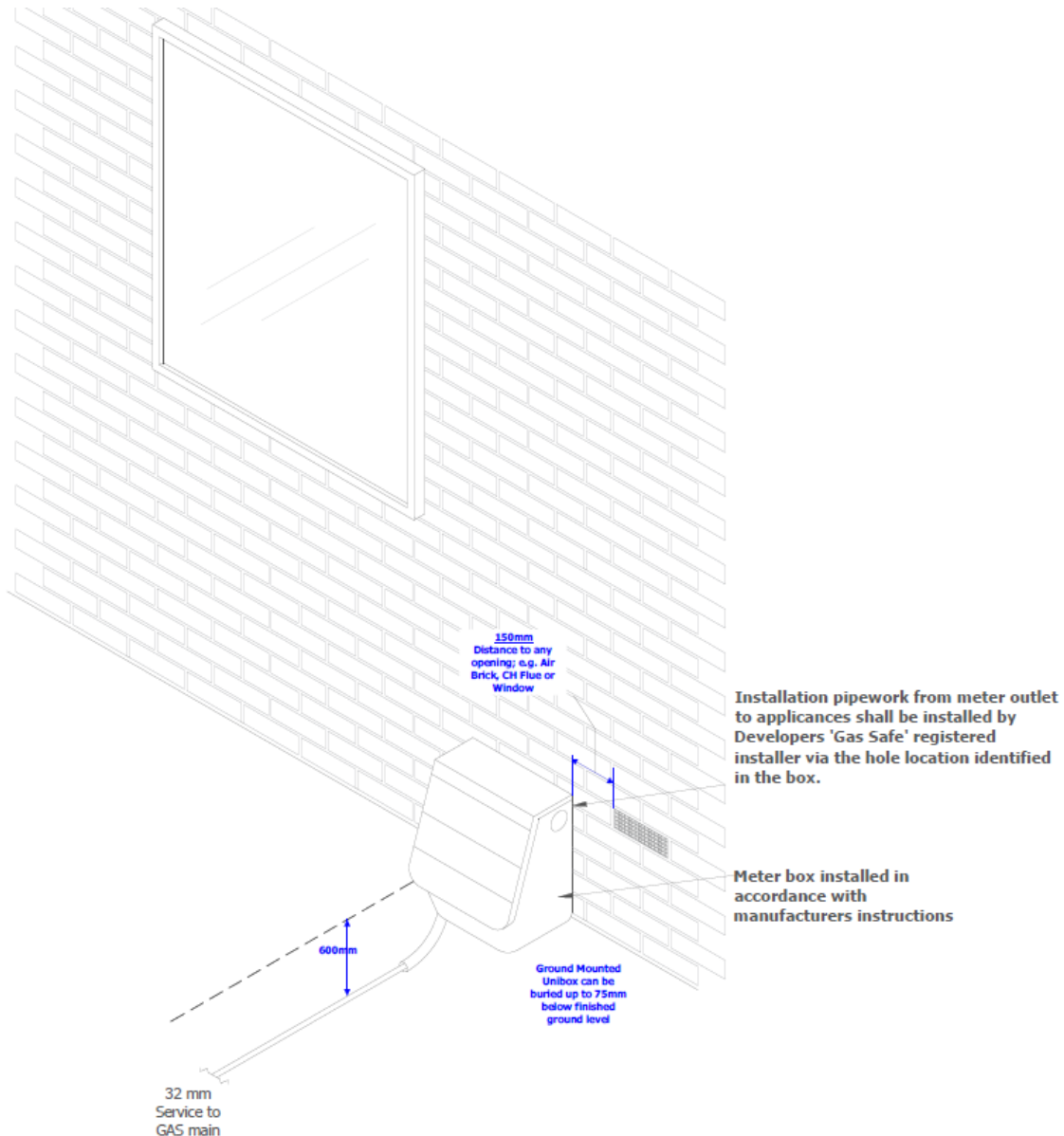

Figure 16 – Universal box installation

Fitted at ground level and submerged into the ground by 75mm or fixed onto the wall ensuring the ground level is as per the indicator on the box. Ensure the box is supported following installation. Fit the meter box lid. Route outlet pipe through right hand side of the box. Make continuity bond to outlet.

To avoid any restriction of air flow, it must not obstruct air bricks and should be sited at least 150mm from any other box. It must be secured to the wall using the spacers supplied with the meter box, wall plugs and screws.

The Unibox can be used as a surface mounted box.

GTC Technical Guidelines

Meters Located Inside

A meter shall be located as near as practicable to the point where the service pipe enters the building or, in the case of a multi-occupancy building, where the service pipe enters each dwelling. Meters shall not be located within the premises or recessed meter boxes.

The meter installation shall not be sited on or under the stairway, or in any other part of the premises, where the stairway or that other part of the premises forms the sole means of escape in case of fire.

For meters located inside, the service entry will be above the damp-proof course using an above ground entry tee and will continue in steel pipe terminating at the meter control valve.

Where a meter is to be located inside the building then it must be in a ventilated cupboard, the ventilation shall be a minimum of 2% of the plan area (1% at high level and 1% at low level) provided by purpose-designed vents of the non-closable type to achieve at least a Zone 2 hazardous area within the meter housing.

Medium Pressure Domestic Meter Installations

Meters supplied from a medium pressure service must be housed externally to the building in a surface mounted meter box, or purpose-built compartment. Meters shall not be located within the premises or recessed meter boxes.

The proposed location for the meter and regulator installation and the design of any purpose-built compartment must be agreed with GTC at the initial design stage.

Note to Developers

Where the outside surface of a building is to be cleaned with a corrosive type washing agent, care must be taken in its application, whether by jetting or brush, to prevent the wash accessing the gas meter box and potentially corroding the meter installation. A waterproof membrane can be used to shroud the meter box during the wash application

Section Nine

Multi-occupancy Buildings

Early consultation with GTC should take place to agree meter locations to flatted properties.

The preferred location for meters supplying flatted properties is in standard meter boxes or a bank of meters in a purpose-built compartment external or adjacent to the building.

When meters are to be located within flatted properties, the location shall be confirmed at the design stage. Where a riser is to be installed, the method of building entry shall be via a building entry tee.

Risk Assessment

A bespoke risk assessment is required for all flatted property installations except external individual meter boxes. The Developer must provide the following information to the GTC Designer relating to the building/block.

- Special occupancy type (e.g. elderly, disabled etc) expected in the building.
- How is 24/7 access guaranteed.
- The type of building construction.
- Detailed floor plans and building layouts.
- Other utility and service routes.

The Developer or the principal contractor acting on behalf of the client will be required to sign the Gas in Flat Risk Assessment at design stage and at pre-commission stage to confirm acceptance.

Multi-meter Compartments

The room, cupboard or compartment door shall not open onto any sole means of escape and shall be self-closing and lockable. Keys to the meter cupboard must be made available to the gas consumer and should be recognised fire brigade (FB2) keys or equivalent.

A meter bank shall be in a room, cupboard, or compartment, designed for the purpose and ventilated in accordance with the details shown on pages 27 & 28.

If the building is of timber frame construction, then an internal riser or bank of meters located on the ground floor is required, refer to the details in **Risers and Laterals**.

GTC Technical Guidelines

Access Requirements

A meter bank installation shall be in a room, cupboard, or compartment, designed for the purpose and ventilated in accordance with the ventilation criteria detailed below.

An enclosure door must be self-closing and lockable. Enclosures which are large enough for persons to enter must be able to be opened from inside without the use of a key. GTC require 24/7/365 access to the meter room via the provision of a key, the Developer must provide this information at an early stage. Door locks shall be of type FB2 or equivalent.

If the meter enclosure is accessible for the purposes of meter reading and maintenance from the front through fully openable doors (full width of compartment) the minimum depth must be 500mm.

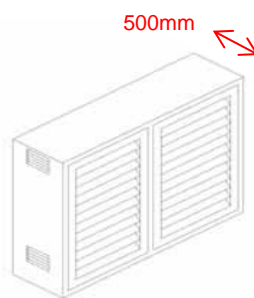

Figure 17 – Meter enclosure (500mm)

If the meter enclosure is accessible through a single door then the minimum depth of the enclosure must be 1300mm providing enough access for meter reading and maintenance purposes. The door must be fully operable from the inside for safe escape purposes.

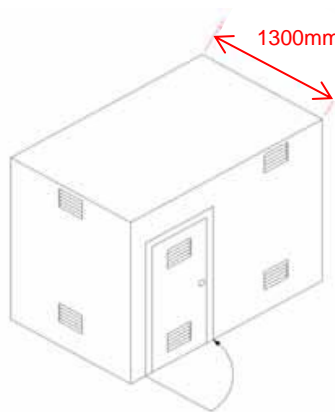

Figure 18 – Meter enclosure (1300mm)

GTC Technical Guidelines

Lighting

A BASEEFA approved electrical switch and light fitting, to be fully compliant with DSEAR, may be used in a properly ventilated meter bank enclosure providing that it is a distance of at least 1 metre away from the meter bank installation and outside any dead zone (i.e. level with the top ventilator).

Any electrical equipment that is closer than 1 metre from the meter bank installation or within any 'dead zone' must be suitable for use in a Zone 2 hazardous area.

Some extra precautions are needed for light fittings installed at ceiling level in an unventilated 'dead zone' above a ventilator.

Please consult your Electrical Engineer for further guidance about DSEAR (Dangerous Substances and Explosive Atmospheres Regulations).

External Compartments

A purpose-built compartment may be located away from the building or set into/against the building structure.

If set into the structure of the building the compartment must be completely sealed except for an external access door and have suitable ventilation direct to outside.

The free area of ventilation required is a minimum of 2% or 3% of the floor area depending on the construction of the compartment. This can be in the form of a fully louvered door or vents evenly distributed at high and low levels. For more detail refer to the Ventilation section below.

Internal Compartments

The compartment and access doors must meet the structural and fire-resistant requirements applicable to the building.

Solid access doors must be self-closing and lockable. The room, cupboard or compartment door shall not open onto any sole means of escape.

GTC Technical Guidelines

Examples of acceptable multi-meter installations

The following drawings show examples of acceptable multi-meter installations:

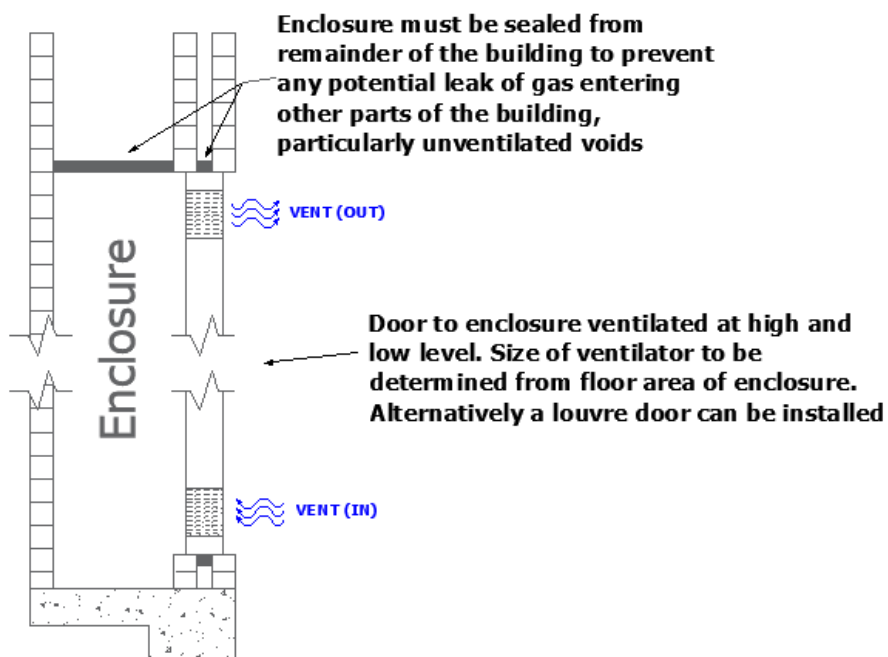
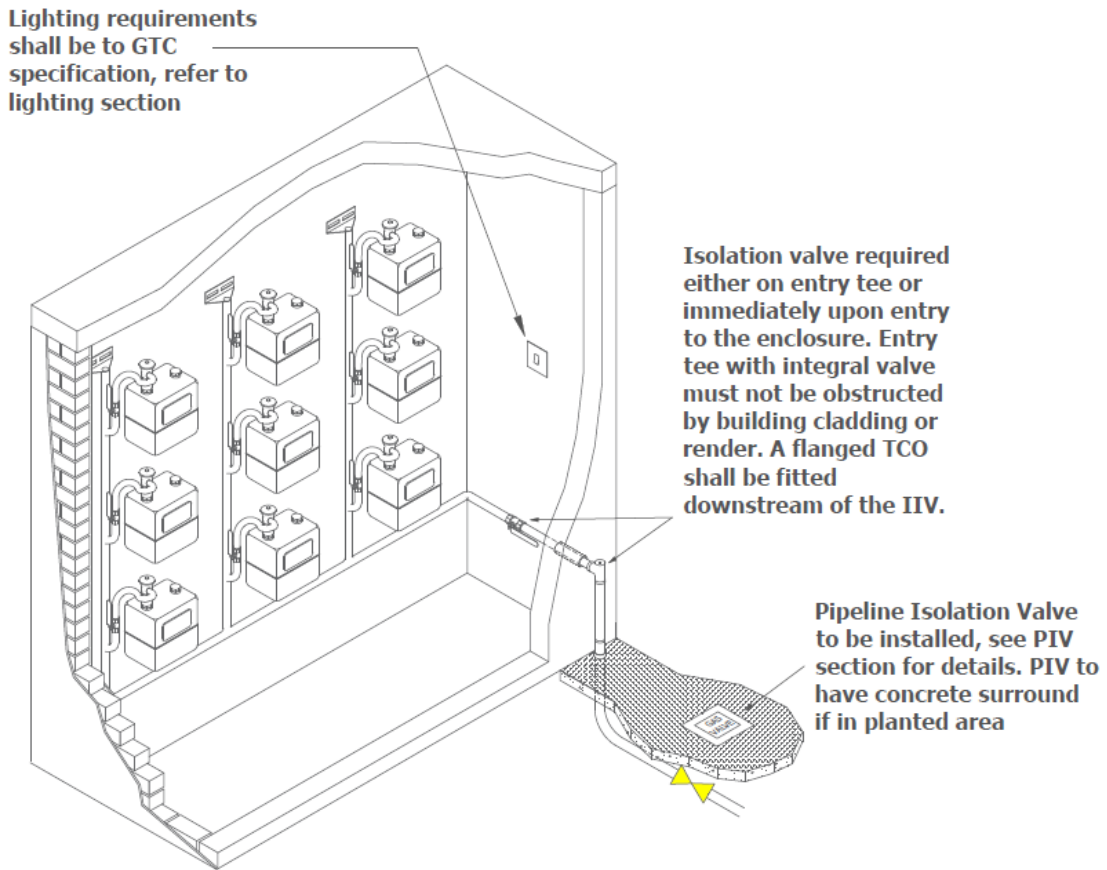

Figure 19 – Purpose built enclosure external to the structure of the building

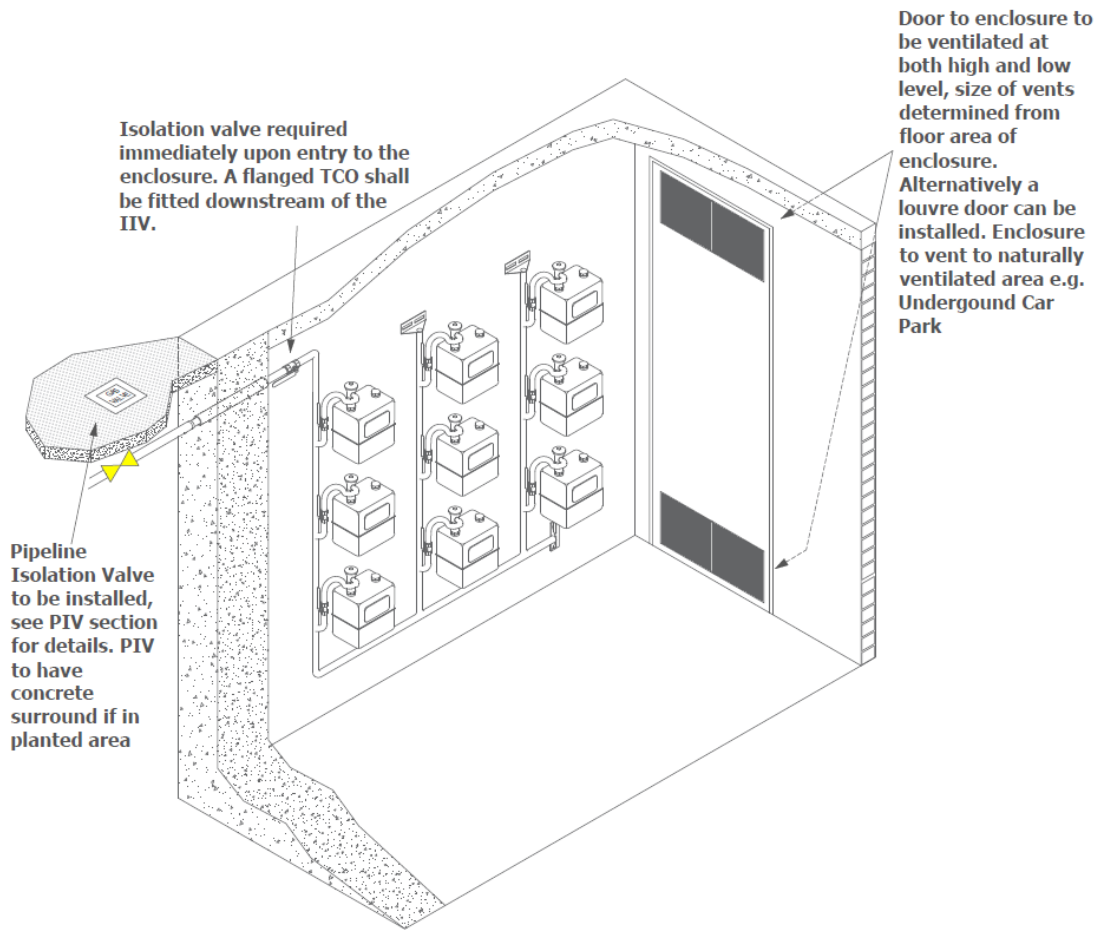

Figure 20 – Purpose built meter room/enclosure opening onto a naturally ventilated basement car park

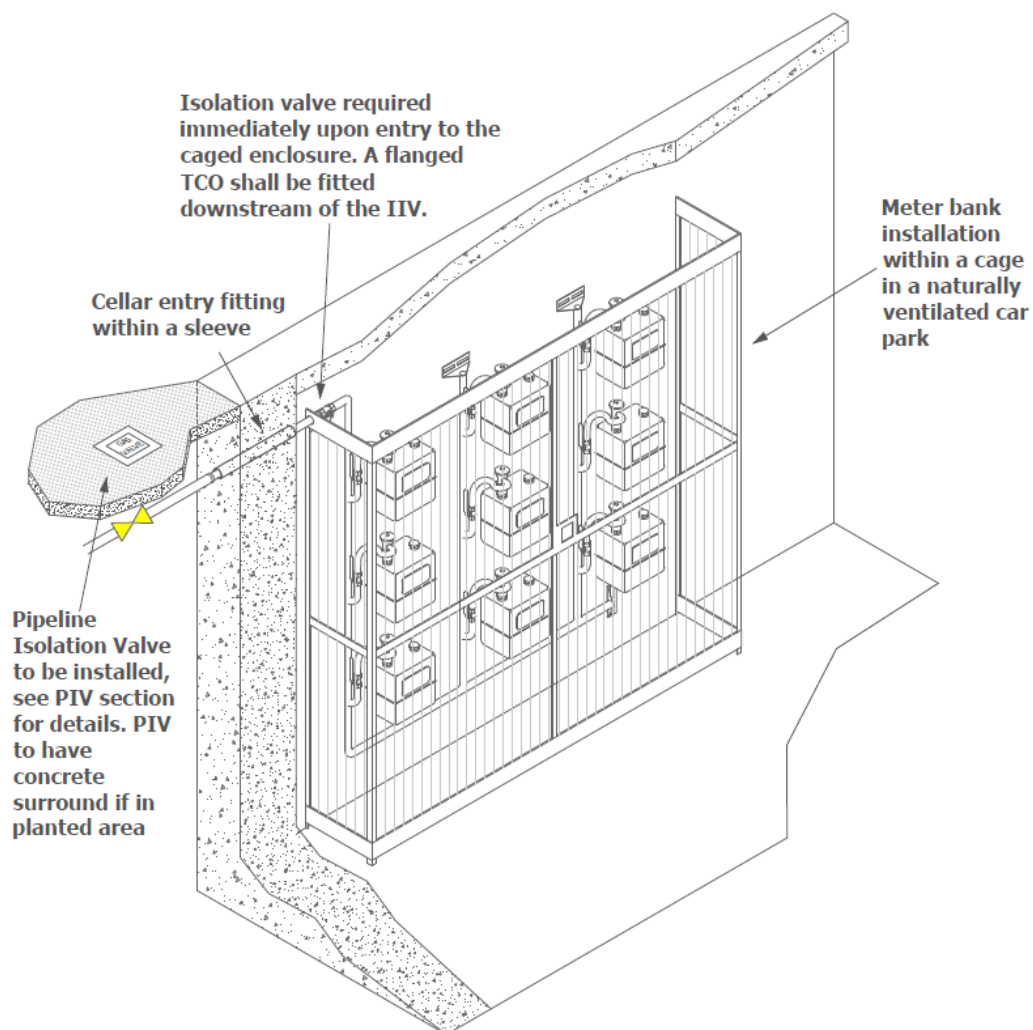

Figure 21 – Purpose built cage compartment in a naturally ventilated basement car park

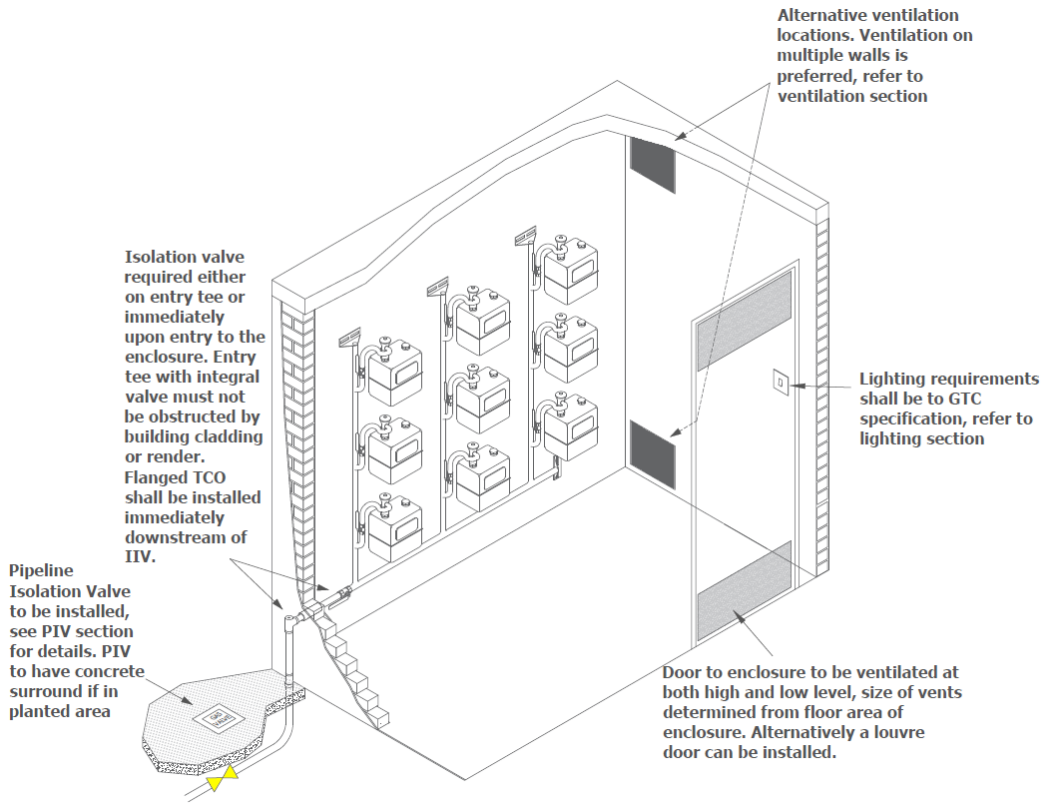

Figure 22 – Purpose built internal enclosure

Risers and Laterals

Risers more than 20 metres high shall be constructed with welded steel. All other riser and lateral systems, where practicable, shall be constructed from welded steel e.g. joints to valves can be flanged connections.

Risers and laterals must not be installed in the ceiling space e.g. false ceiling, unless it welded and contained within an independent sealed duct.

Risers may run in the same duct as other services; however, consideration should be given to the proximity of electrical apparatus so that it does not obstruct the route of the riser. The minimum distance from a riser to electrical cables must be 25mm. The riser must not be installed in a duct if it contains other apparatus that operates in vacuum conditions or contains oxidising or corrosive materials. Guidance is given in BS 8313:1997 Code of Practice for *Accommodation of Building Services in Ducts*.

To allow for movement a sleeve is required through any boxing/plasterboard for each lateral pipe passing through from the riser to the meter positions. The sleeve shall be filled with either fire retardant non-setting mastic or alternatively a fire-retardant silicone sealant to allow for movement of the lateral pipe installed. It is not acceptable for any plasterboard to be in direct contact with the lateral pipe resulting in restraining the lateral and preventing movement.

Risers and laterals shall be sleeved where they pass through any floor or wall.

GTC Technical Guidelines

External Risers

External risers, up to a maximum of 2 floor levels, will be secured to the outside of the building and shall not be hidden behind a cover or enclosure.

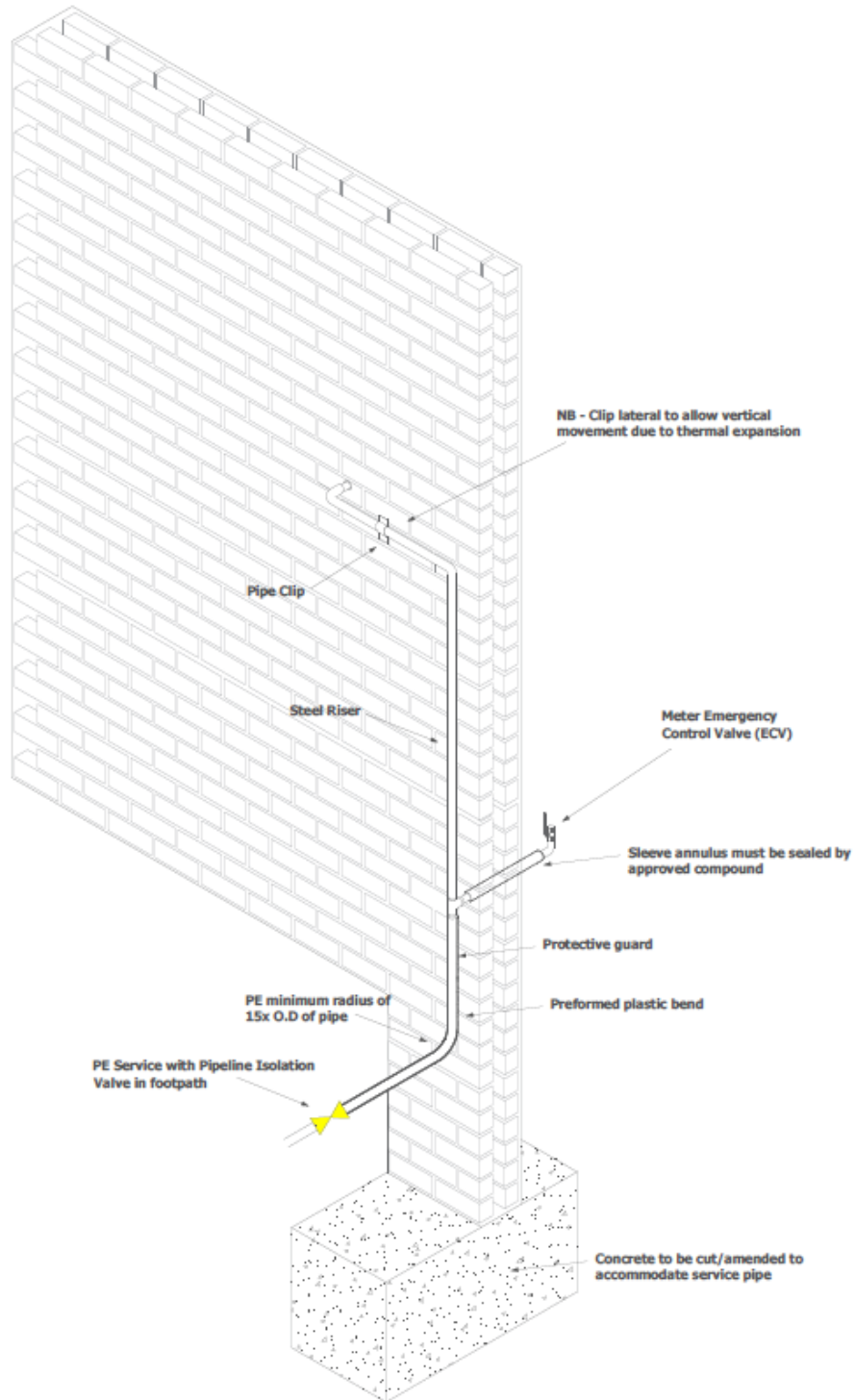

Figure 23 – External risers up to a maximum of 2 floor levels

GTC Technical Guidelines

Internal Risers

A riser can only be installed in a shaft, duct, or void, which has adequate ventilation. If the riser is to be enclosed in a continuous duct or an enclosure, the duct or enclosure must be constructed so that it has at least half an hour fire resistance and naturally ventilated at high and low levels.

Where the duct is not continuous, it should be ventilated at the top and bottom of each isolated section as shown below.

When a riser is installed in a ventilated duct or enclosure, fully removable panels must be provided to allow for access to carry out any future maintenance work. Access to valves shall be via doors constructed into the ventilated duct. Opening/closing the door must not compromise the integrity of the fire-sealing of the duct.

When risers are not installed in a duct or enclosure, they shall be ventilated indirectly to outside air via an area that is normally occupied and is itself ventilated to outside air, in accordance with Building Regulation requirements.

Further detailed guidance can be found in the Institution of Gas Engineers and Managers document IGE G/5. Visit website www.igem.org.uk.

GTC Technical Guidelines

The following drawings show examples of acceptable internal riser designs:

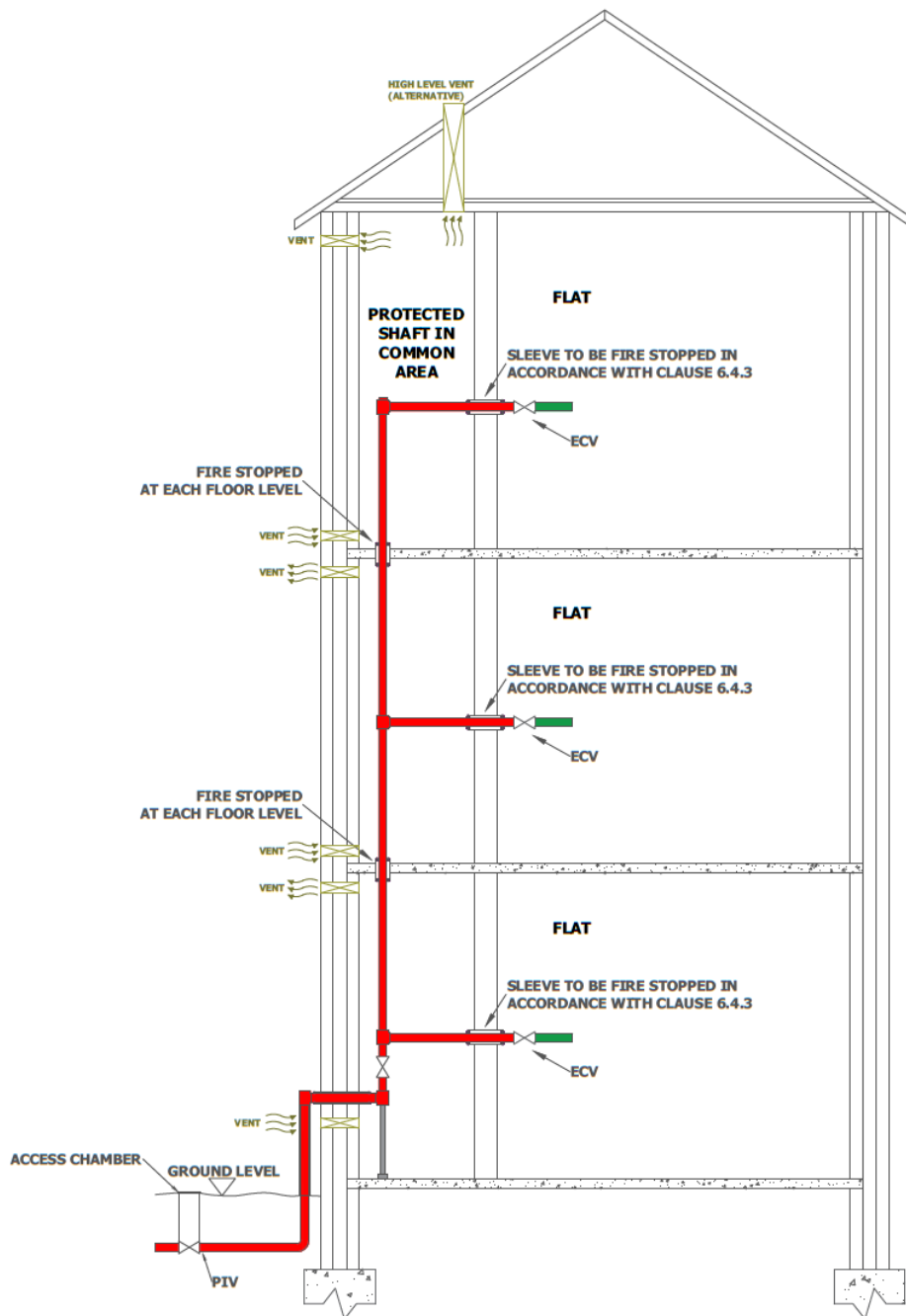

Figure 24 – Internal screwed/welded riser passing through a protective shaft on an outside wall ventilated direct to outside air at each level. Meter locations back on to the riser

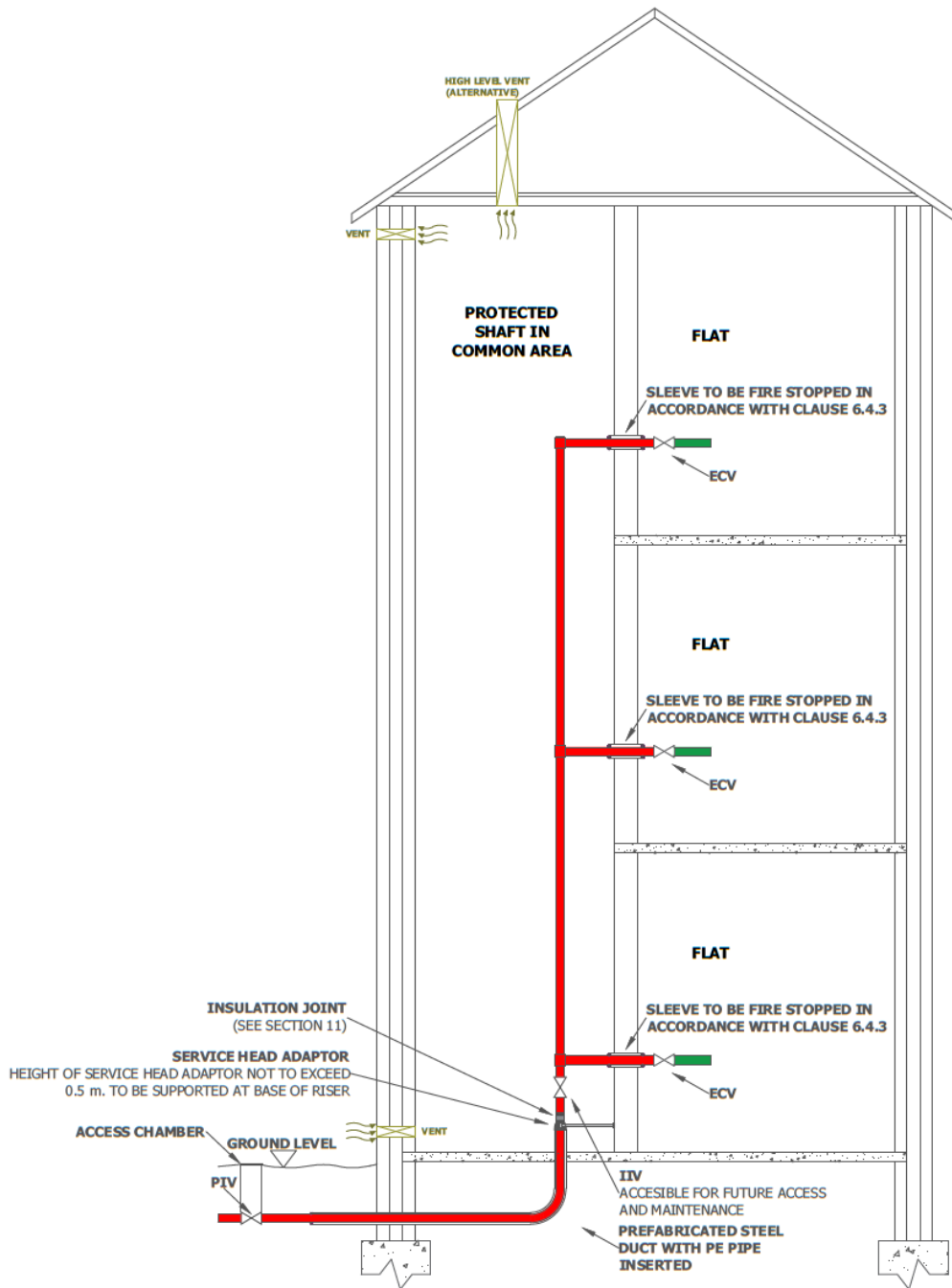

Figure 25 – Internal screwed riser passing through a protective shaft on an outside wall ventilated direct to outside air at the top and bottom of the riser. Meter locations back on to the riser

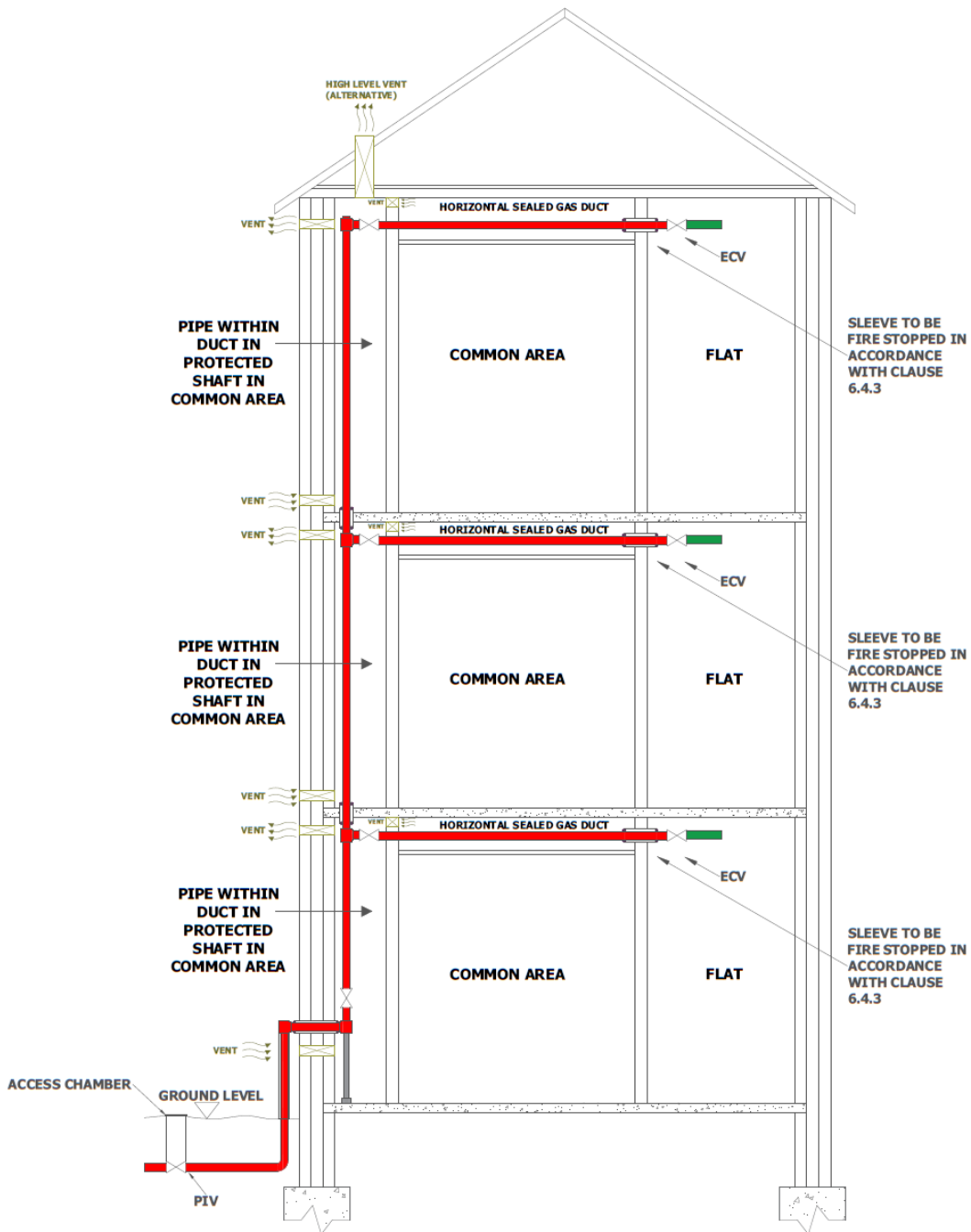

Figure 26 – Internal screwed riser passing through a protective shaft on an outside wall ventilated direct to outside air at each level. Meter locations remote

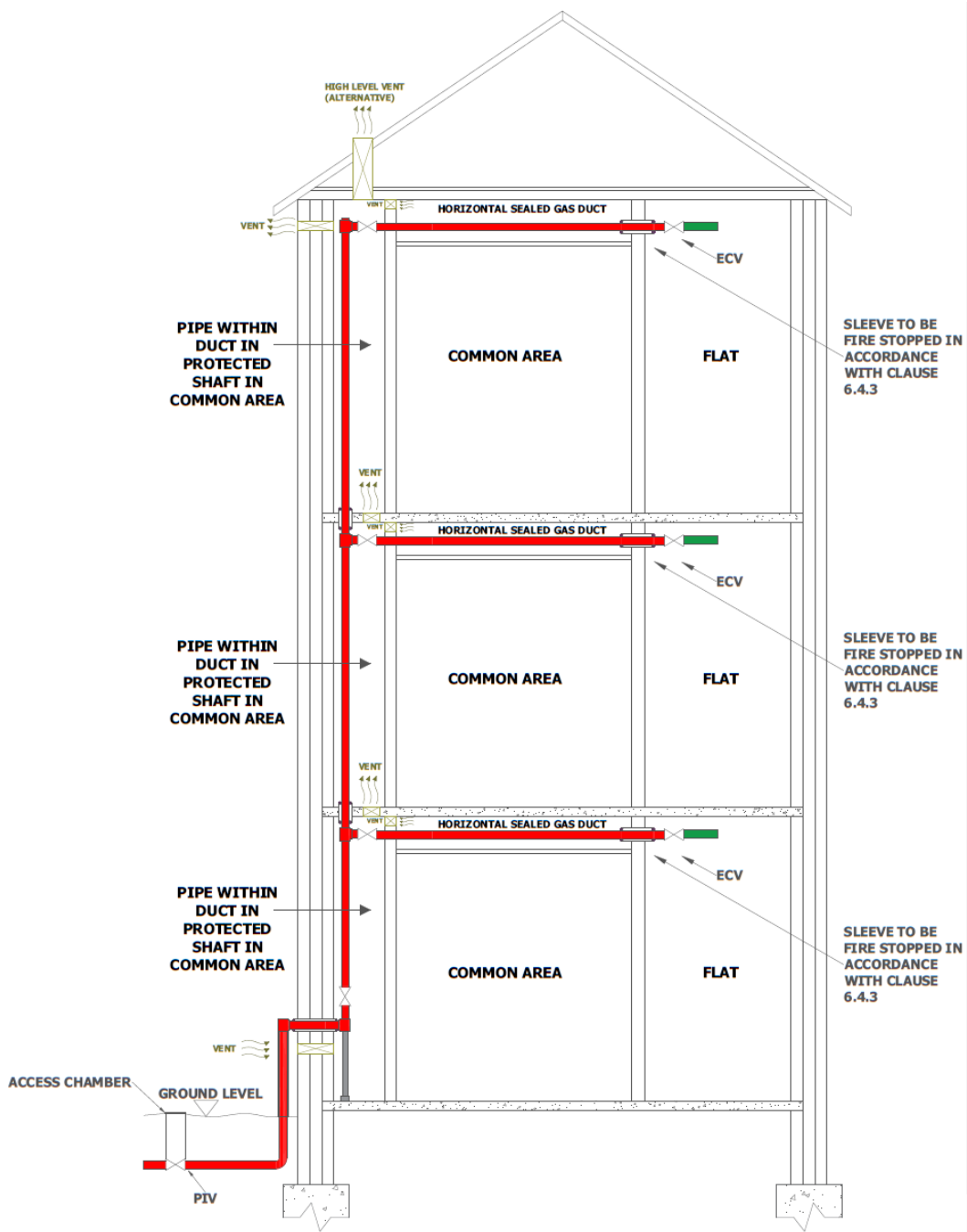

Figure 27 – Internal screwed riser passing through a protective shaft on an outside wall ventilated direct to outside air at the top and bottom of the riser. Meter locations remote

GTC Technical Guidelines

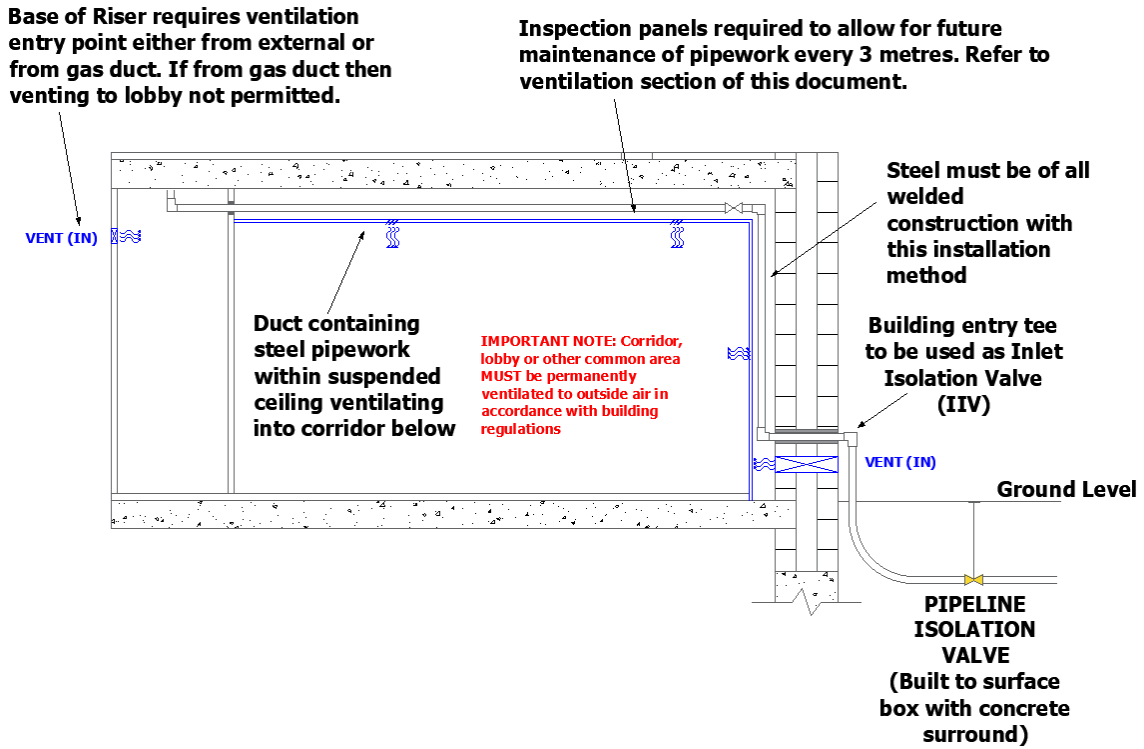

Figure 28 – Internal welded riser with duct indirectly ventilated to outside air via the corridor, lobby, or other common area

GTC Technical Guidelines

Timber Framed Flats

External risers are not permitted on multi-storey timber framed buildings.

Internal risers and laterals must be designed to accommodate relative movement. The inner leaf wall can shrink with respect to the outer leaf by as much as 12.5mm per floor.

To accommodate the relative timber movement, cored holes for the lateral sleeves must be oversized to ensure that no excessive stress is applied to the sleeve during the 'shrinkage'.

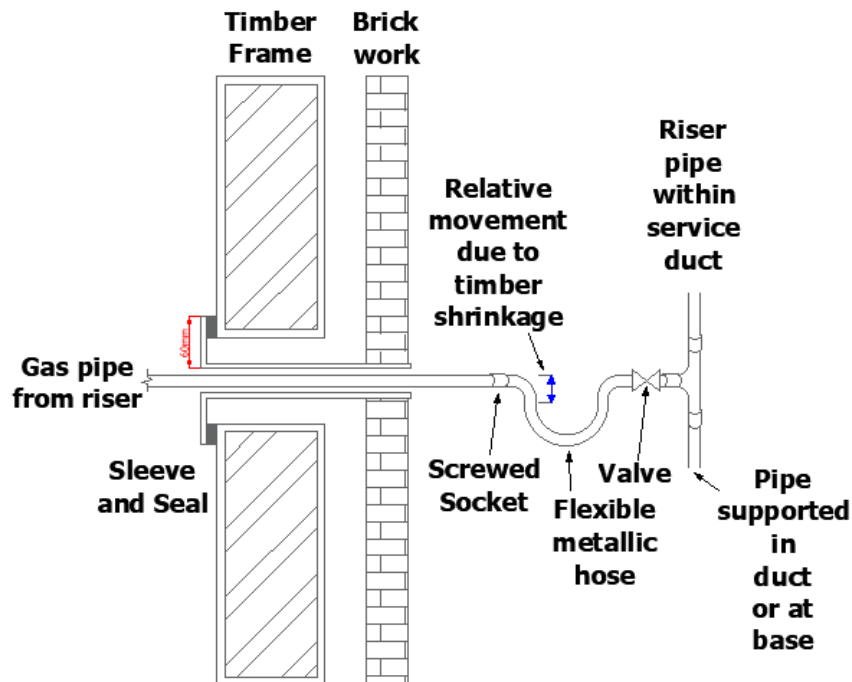

Figure 29 – Type of flanged sleeve that will be installed by GTC to prevent any possibility of gas entering the cavity

Discussion must take place with GTC at the initial design stage to agree the gas service arrangements.

GTC Technical Guidelines

Preventing Spread of Fire

Fire stopping and protection from fire must be constructed and in place prior to the commissioning of any gas pipes within multi-occupancy buildings, written confirmation is required from the Developer confirming fire stopping and ventilation is not compromised.

Risers and laterals shall be fire stopped between fire compartments in accordance with Building Regulations.

The following diagrams provide details of fire stopping and sleeving requirements for risers and laterals passing between floors or fire compartments:

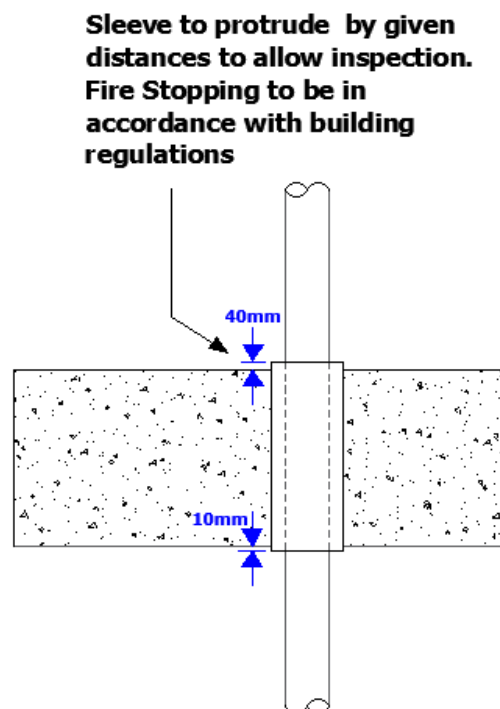

Figure 30 – Sleeves are required to terminate 40mm above floor level and 10mm below so that it is visible for inspection

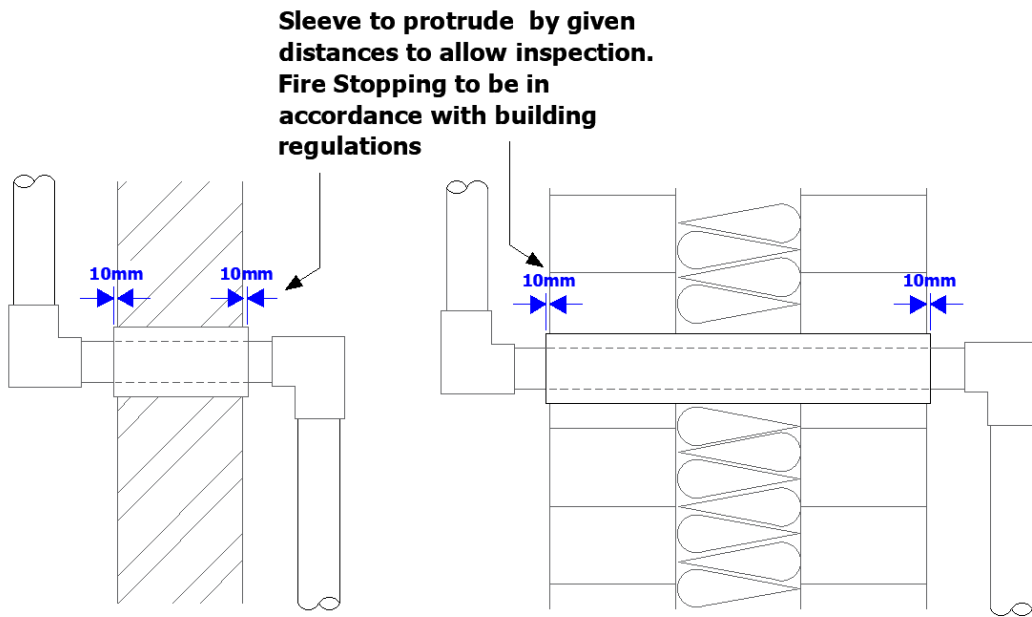

Figure 31 – Fire stopping and sleeving requirements for risers and laterals passing through walls or between fire compartments

Provision shall be made for the installation and access of a gas tamperproof emergency valve by GTC in a location that is close to the point of entry of the gas service from the outside and is accessible to the fire brigade and GTC for maintenance purposes. The valve should not be accessible to the public.

Access must be provided to meter enclosures/cupboards and such access shall be restricted to gas consumers and authorised persons. Door locks should be type FB2 or equivalent.

Emergency control valves must not be boxed in and must always remain visible and accessible.

GTC Technical Guidelines

Ventilation

Ventilation to the outside atmosphere must be provided through suitably sized and constructed ducts, provided at high and low level. Ducts should be protected and constructed to prevent fire damage.

Refer to BS 8313 for duct sizing and further detail.

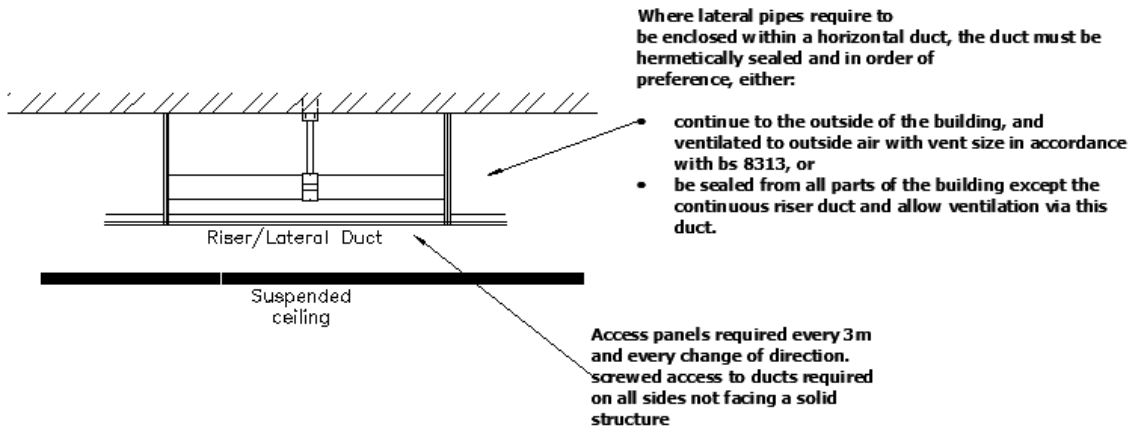

Figure 32 – Ventilation (side elevation)

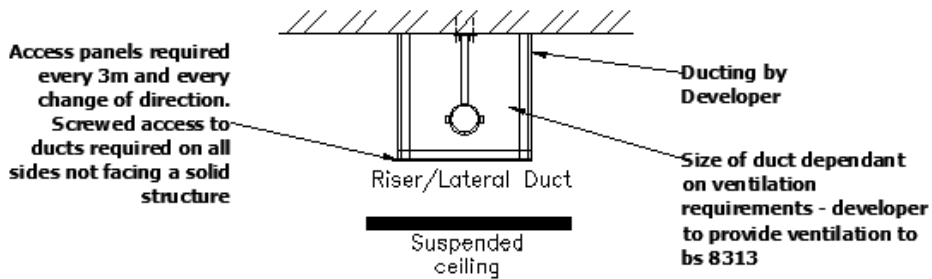

Figure 33 – Ventilation (front elevation)

GTC Technical Guidelines

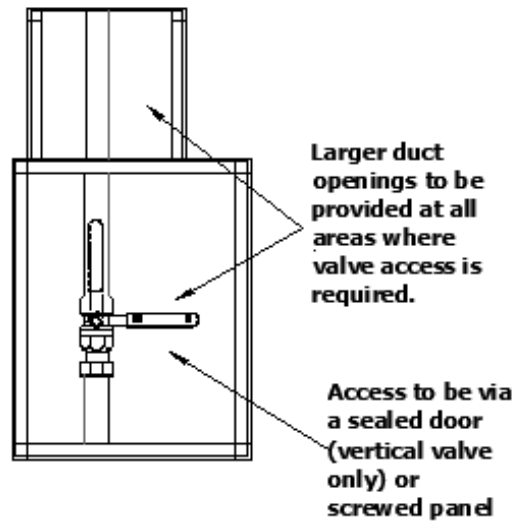

Figure 34 – Vertical valve access (front elevation)

No gas pipes should be routed in any shaft, duct, or void, which is not adequately ventilated. If the entry to the compartment is via a riser or lateral then it shall be enclosed in a duct or an enclosure, the duct or enclosure must comply with the building regulations and shall be at least half hour fire resistant and naturally ventilated to outside air at high and low levels to BS 8313 and must have removable access/inspection panels.

It is possible to consider installing louvre doors which would provide sufficient free area as an alternative to fitting ventilators at high and low level. However, unventilated “dead zones” above louvre doors should be avoided by fitting a further vent at high level.

Meter enclosures/cupboards shall have a minimum ventilation of 2% of the nominal floor area when the ventilation is on two or more walls and 3% when the ventilation is on one wall only.

The ventilation shall be natural to outside air and be evenly distributed at high and low levels. Guidance is given in BS6400 part 1. The nominal floor area is 0.5m² per gas meter:

For example, a room housing 6 gas meters will have a nominal floor area of 3m², and therefore vents having free area of 0.03m² are required at both top and bottom if the 2% option is chosen. Details of the design shall be forwarded by GTC to the Principal Designer in accordance with CDM.

GTC Technical Guidelines

The following table indicates the ventilation requirements:

Number of external walls	Minimum area of free ventilation required as a percentage of the compartment floor area	Type of natural ventilation required to the outside	Position of low-level vents	Position of high-level vents
1	3%	Louvered door or high- and low-level indicators	150mm above the floor	As close as possible below, but no more than 10% of the total compartment height below, the roof or ceiling level
2	2%	High- and low-level ventilators	150mm above the floor	
3	2%	High- and low-level ventilators	150mm above the floor	
4	2%	High- and low-level ventilators	150mm above the floor	

Ventilators fitted through an external wall to outside air must be sleeved and sized accordingly based on the free area required. Mechanical ventilation, closable vents or vents fitted with insect mesh are not acceptable and must not be installed. Note: The ventilation area must be calculated, it is not the perimeter size of the ventilator but the actual area of slots or holes.

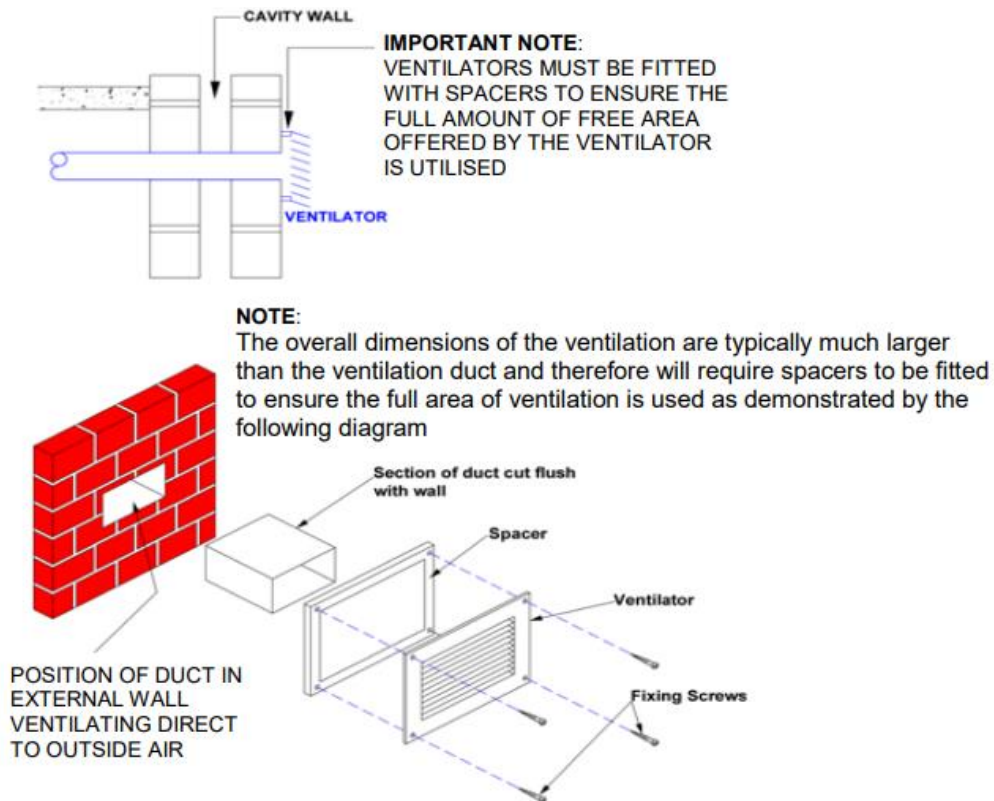

Figure 35 – Spacers must be used to ensure the full free area offered by the vent

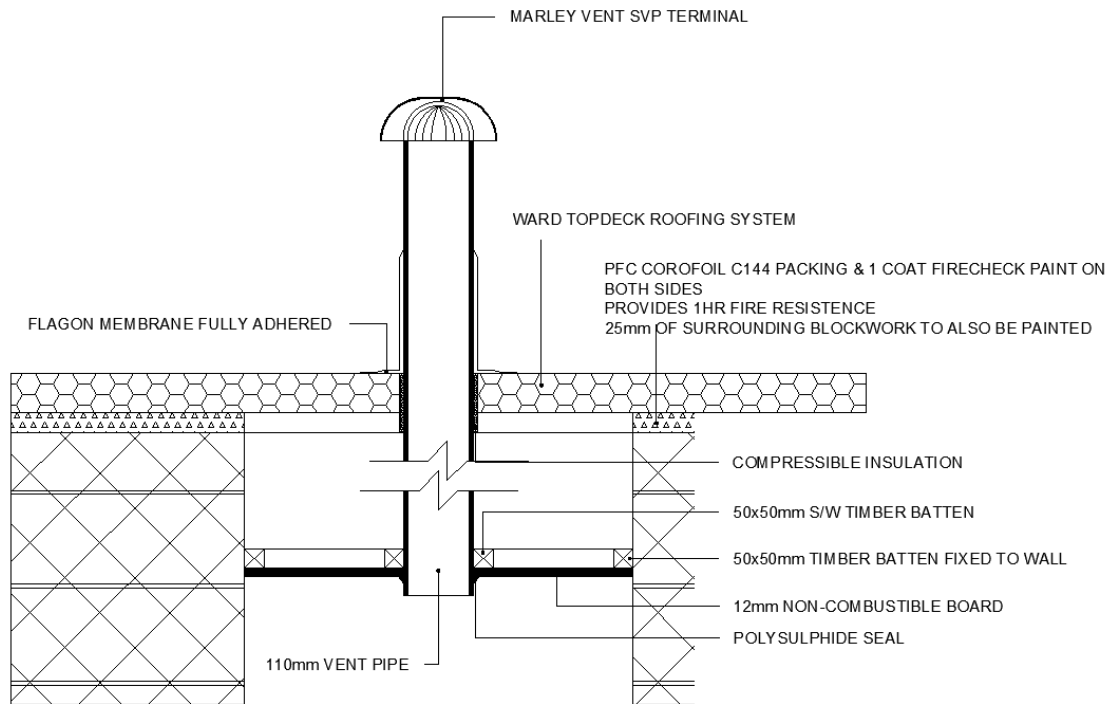

Figure 36 – Example specification if riser shafts are to be ventilated via rooftop ducts. The detail shall be determined by the Developer

Section Ten

Pressure Reduction Installations

When a Pressure Reduction Installation (PRI) is required, its position must be agreed with GTC at the design stage. A land transfer and access easement are required, and these must be completed before the PRI is commissioned by GTC.

Location

- The PRI must be sited to avoid the possibility of vehicular impact and weight of vehicles parking or running over the pit covers. Where this risk is identified traffic protection measures such as bollards or barriers must be installed by the Developer.
- The PRI must be located away from where the water table is high, or the potential of flooding exists.
- The proximity to buildings must be considered. For medium to low pressure installations this must be sited at least 3 metres from the nearest property or ignition source. For immediate pressure installations the distance will be specified by the GTC Designer.
- There must be constant access for future maintenance or any potential emergency works including a dedicated parking space allocated for a maintenance vehicle.

PRI Installation Process

For a PRI to be installed the below process should be followed to avoid delays in commissioning of the on-site gas infrastructure:

- A PRI civils drawing will be provided by GTC as part of the design.
- A pre-start on-site meeting with a GTC representative must take place to confirm the exact location of the PRI, details of excavation, construction of the concrete slab and reinstatement requirements which is the responsibility of the Developer.
- Agreement that the location of the installation is acceptable to both GTC and the Developer.
- The site is ready to accept the installation.
- Prior to or immediately following PRI commissioning a GTC auditor will also assess the quality and completeness of the installation with actions on the Developer to complete works.

GTC Technical Guidelines

Below Ground Installations

Below ground installations shall be installed as per the civil drawing provided and as per the below requirements:

- The installation shall be installed on a 200mm thick C40 concrete constructed in accordance with BS EN 206-1 with 2 x layer of A252 steel reinforced mesh manufactured to BS 4483:2005.
- The slab shall be constructed on a layer of GSB 1 Class A graded granular material.
- The vent stack must be installed at a maximum of 10m from the module and a minimum of 3m from any property and marker tape must be laid over the route of the vent pipes.
- The below ground module should be backfilled with module fine grade granular material 3-6mm up to a level of 100mm below ground level. The module cover must have a 600mm wide 100mm thick surround of C40 concrete constructed in accordance with BS EN 206-1 with 2 x layer of A252 steel reinforced mesh manufactured to BS 4483:2005. The site surface shall be finished such that any water run-off is not onto the lid.



Figure 37 – An example of how the below ground installation should be finished

GTC Technical Guidelines

Above Ground Installations

Above ground installations shall be installed as per the civil drawing provided and as per the below requirements:

- PRI Kiosks shall be permanently attached to a 200mm thick C40 concrete slab constructed in accordance with BS EN 206-1 with 2 x layer of A252 steel reinforced mesh manufactured to BS 4483:2005.
- The slab shall be constructed on a layer of GSB 1 Class A graded granular material.
- The concrete base shall finish above ground level and its dimensions shall extend 200mm beyond the perimeter of the kiosk.
- The mesh reinforcement should be used throughout the whole of the 'H' shaped design.

The area around the inlet and outlet pipes shall be back filled with pea gravel once the installation has been installed.



Figure 38 – An example of how a large above ground installation should be finished

GTC Technical Guidelines



Figure 39 – An example of how a small above ground installation should be finished

Fire Valve Requirements

There must be a fire valve installed on the inlet of a PRI and one can be required on the outlet, if this is required it will be specified on the design drawings. The valve nest shall be finished by the Developer to the following specifications:

- When backfilling around the valve chambers fine grade granular material 3-6mm shall be used up to a level of 100mm below ground level. The valve covers must have a 200mm wide 100mm thick concrete surround constructed in accordance with BS 6400-2 and BS EN 206-1. The site surface shall be finished such that any water run-off is not onto the valve lid.
- The valves must be sited to avoid the possibility of vehicles parking over the pit covers.
- GTC must have 24hr access to the valve nest, as the fire valve is the point of isolation for gas emergencies.



Figure 40 – An example of how the valve nest should be finished

GTC Technical Guidelines

Recording and Labelling

Marker posts shall be installed next to each valve and where appropriate next to below ground PRIs. The faceplate shall include the GTC Logo, emergency contact details and 'blank' operating pressure. The kiosk or vent pipe shall have signage showing the site number and GTC emergency contact details, 'Ex' for DSEAR, no naked lights, no excavation work, PPE requirement. The installation operative shall complete the commissioning sheet and layout sketch. Examples of the signage required are shown below.



Figure 41 – Examples of the signage required

Section Eleven

Non-domestic Supplies

The preferred location is external to the building and as close as possible to the gas main.

When the meter must be inside the building it should be located adjacent to an outside wall, with adequate ventilation and protected against accidental damage but not near electrical switchgear, heating, or process equipment.

For any meter installation to be installed in non-domestic premises, confirmation shall be obtained from the responsible person for the site of any existing hazardous area classification for the proposed location. Prior to the fitting of such a meter installation, a hazardous area assessment shall be undertaken in accordance with BS EN 60079-10-1 or IGEM/GM/7B.

Meter Housings

The walls of a purpose-built compartment must be of solid construction without a cavity and must not include openings other than those required for access, ventilation, pipe work or other ancillary services.

The compartment should not be used for purposes other than regulating and metering the gas supply.

The total effective ventilation area of the compartment must be at least 2% of the floor area distributed equally at high and low levels over two or more walls. If ventilation is only available on one wall e.g. through louvered doors, it must be at least 3% of the floor area.

For small diameter above ground entries, a service entry tee with a close fit sleeve should be used.

Table 3 – The wall at the entry point should be drilled using the correct sized core drill to match the close fit sleeve diameter

Service entry tee	25mm	32mm	63mm
Core drill diameter	35mm	45mm	80mm

GTC Technical Guidelines

Meter Installations

To arrange for the meter to be installed the Developer should contact their chosen Gas Shipper.

A meter will only be fitted once the Shipper has been confirmed and GTC receives the appropriate instruction from the Shipper.

The meter will then be fitted after the GTC Installer has checked and confirmed that the ventilation requirement for the type of meter is adequate.

Medium Pressure Non-Domestic Supplies

Medium Pressure Installations for non-domestic use shall be in accordance with PRIs (see section 10). The Developer should arrange the installation of metering equipment with their appointed Meter Asset Manager.

Non-Domestic Service Valves

Service valves are required to be installed when service pipes:

- Are 63mm or larger.
- Supply properties where there is special risk of personal injury, fire, explosion, or other dangers arising from the use of gas.
- Supply more than one primary meter in the property.
- Are MP/IP services supplying Commercial or Industrial end-users

Service valves should be installed a minimum of one metre from the building, as near as possible to the property boundary and clearly indicated or visible. They should be in an accessible position and clearly indicate the location with a surface cover marked G or GAS.

Service valves should not be installed in any position where they cannot be used safely.

Section Twelve

Installing Meters and MPRN Issues

To ensure that the process of installing meters runs smoothly it is essential that accurate address details are provided to enable GTC to organise network development, meter provision and account creation.

Plot to Postal Address

Plot to postal address issues have long been identified as causing confusion within the new connections area. GTC have developed the following guidance to make the new connection process as clear and simple as possible.



As shown above, the confirmation of address data has several approval points. There are no defined timescales for approval by the Local Authorities. Royal Mail also retains the right to veto address applications until they issue postcode. For these reasons Developers are advised to begin the address application process as soon as possible following planning approval to allow sufficient time for processing.

The guideline from local authorities and Royal Mail is approximately 12 weeks.

MPRN Allocation

It is GTC's preference to issue MPRN's upon confirmation of the postal address and postcode from the Developer. Without the MPRN being issued GTC cannot install the gas meter. GTC recognise that in all cases this is not always possible and will work flexibly to help developers. On large developments, MPRNs shall be allocated in a phased manner to enable better data quality as plans come to fruition. The Developer should ensure that the plot to postal information provided is accurate in order to aid correct MPRN allocation.

GTC Technical Guidelines

Installation and Crossed Meters

The potential for crossed meters (meter information allocated to the wrong postal address) is a particular problem in the industry, especially for high density developments (flats). To minimise the potential for errors the following system is recommended.

The Gas Safety Registered installer must ensure that the meter and meter location is indelibly marked up with the address of the dwelling served when the installation pipe is installed. It is essential from a safety perspective that the customer knows which emergency control valve and meter relates to their property.

Section Thirteen

Appendices

GTC Technical Guidelines

Appendix

Developers register of their groundworkers who have been trained and are competent to lay gas service pipe and ducting.

Groundworkers name	Groundworkers signature	Site Manager/ Agent name	Site Manager/ Agent signature	Date



Head Office

Synergy House
Woolpit Business Park
Woolpit
Bury St Edmunds
Suffolk
IP30 9UP

T: 01359 240363

E: info@gtc-uk.co.uk

W: www.gtc-uk.co.uk